

Explosives

JACQUES BOILEAU, Consultant, Paris, France

CLAUDE FAUQUIGNON, ISL Institut Franco-Allemand de Recherches de Saint-Louis, Saint-Louis, France

BERNARD HUEBER, Nobel Explosifs, Paris, France

HANS H. MEYER, Federation of European Explosives Manufacturers, Brussels, Belgium

1. Introduction	621	3.5. Perforators, Shaped or Hollow Charges . .	634
2. Physical Properties and Chemical Reactions	624	4. Primary Explosives	634
2.1. Detonation	624	5. Secondary Explosives	636
2.1.1. Ideal Detonation	624	5.1. Production	636
2.1.2. Deflagration and Detonation	625	5.2. Specific Secondary Explosives	637
2.2. Prediction of Detonation Data	625	5.2.1. Nitrate Esters	637
2.2.1. Complete Calculation	625	5.2.2. Aromatic Nitro Compounds	639
2.2.2. Approximation Methods	625	5.2.3. <i>N</i> -Nitro Derivatives	641
2.3. Nonideal Detonation Waves and Explosives	626	6. High Explosive Mixtures	643
2.3.1. Nonideal Explosive Compositions	627	6.2. Desensitized Explosives	643
2.3.2. Detonation of Cylindrical Cartridges	627	6.3. TNT Mixtures	644
2.3.3. Low- and High-Order Detonation Velocity . .	628	6.4. Plastic-Bonded Explosives (PBX)	644
2.3.4. The Effect of Confinement	628	7. Industrial Explosives	645
2.4. The Buildup of Detonation	629	7.1. Dynamites	645
2.4.1. Combustion – Deflagration – Detonation Transition (DDT)	629	7.2. Ammonium Nitrate Explosives (Ammonites)	646
2.4.2. Shock-to-Detonation Transition (SDT)	629	7.3. Ammonium Nitrate/Fuel Oil Explosives (ANFO/ANC Explosives)	647
2.4.3. Shock and Impact Sensitivity	630	7.4. Slurries and Water Gels	647
2.5. Classification of Explosives	630	7.5. Emulsion Explosives	647
2.6. Functional Groups	631	7.6. Uses	648
2.6.1. Nitro Group	631	8. Test Methods	649
2.6.2. Other Groups	631	8.1. Performance Tests	649
3. Application	632	8.2. Safety	650
3.1. Energy Transfer from the Explosive to the Surroundings	632	9. Legal Aspects and Production	651
3.1.1. Shock and Blast Waves	632	9.1. Safety Regulations	651
3.1.2. Casing and Liner Acceleration	632	9.2. Production of Military Explosives	651
3.2. High Compression of Solids	633	10. Toxicology and Occupational Health	652
3.3. Metal Forming and Welding	633	References	652
3.4. Rock Blasting	634		

1. Introduction

An *explosion* is a physical or chemical phenomenon in which energy is released in a very short time, usually accompanied by formation and vigorous expansion of a very large volume of hot gas:

1. Mechanical explosions are caused by the sudden breaking of a vessel containing gas under pressure

2. Chemical explosions are caused by decomposition or very rapid reaction of a product or a mixture
3. Nuclear explosions are caused by fission or fusion of atomic nuclei
4. Electrical explosions are caused by sudden strong electrical currents that volatilize metal wire (exploding wire)
5. Astronomical explosions are caused by solar flare activity on most stars

- Natural explosions are caused, e.g., by volcanic eruptions when evaporation of dissolved gas in the magma results in a rapid increase in volume

Only chemical explosions are treated in this article.

For an explosion to occur, the reaction must be exothermic; a large amount of gas must be produced by the chemical reaction and vaporization of products; and the reaction must propagate very fast. For example, gasoline in air burns at a rate of ca. 10^{-6} m/s; a solid propellant, at ca. 10^{-2} m/s; and an explosive detonates at a rate of ca. $10^3 - 10^4$ m/s (detonation velocity).

The two different modes of decomposition are deflagration and detonation. *Deflagration* exhibits two characteristics: 1) the combustion is very rapid (1 m/s up to a few hundred meters per second) and 2) the combustion rate increases with pressure and exceeds the speed of sound in the gaseous environment, but does not exceed the speed of sound in the burning solid. The materials are often powdered or granular, as with certain pyrotechnics and black powder. *Detonation* is chemically the same as deflagration, but is characterized by a shock wave formed within the decomposing product and transmitted perpendicularly to the decomposition surface at a very high velocity (several thousand meters per second) independent of the surrounding pressure (see Chap. 2).

Explosive substances can be divided into three classes. Members of the first class detonate accidentally under certain conditions. These are explosible substances, some of which are used in industry as catalysts (e.g., peroxides), dyes, and fertilizers. This class includes products or mixtures whose formation must be avoided or controlled, e.g., firedamp, or peroxides in ethers. In the second class are products normally used for their quick burning properties but which may detonate under some circumstances, e.g., pyrotechnic compositions, propellants, and some kinds of hunting powder. In the third class are substances intentionally detonated for various purposes.

For reasons of safety, acquaintance with the first group of materials is necessary. The second group is described elsewhere (\rightarrow Propellants; \rightarrow Pyrotechnics). Pure substances and mixtures of the third class are described here.

The distinctions between these three classes are not clear-cut because most explosives burn smoothly if they are not confined. However, if some fine hunting powder burns under certain confined conditions, combustion may become detonation. Dry nitrocellulose fibers can easily detonate, but this tendency is significantly lower in the gelatinized form. Some compositions, such as mixtures of cyclotrimethylenetrinitramine (RDX) with a binder, can be used as a propellant, gunpowder, or high explosive, depending on the type of initiation.

The third class consists of primary and secondary explosives. *Primary explosives* like lead azide (initiator explosives) detonate following weak external stimuli, such as percussion, friction, or electrical or light energy. *Secondary explosives* such as pentaerythritol tetranitrate (PETN) or 2,4,6-trinitrophenyl-*N*-methylnitramine (Tetryl) are much less sensitive to shock. However, they can detonate under a strong stimulus, such as a shock wave produced by a primary explosive, which may be reinforced by a booster composed of a more sensitive secondary explosive. The various secondary explosives are used militarily or industrially as shown in Figure 1.

Functions and Constraints. Explosives can be either pure substances or mixtures. They function in such systems as munitions, where they are a component of a complex firing system, or as firing devices in mining, quarries, demolition, seismic exploration, or metal forming equipment. With such systems, the ingredients must fulfill one or more functions, while meeting various constraints arising in manufacture or use. Therefore, tests that represent these functions and constraints are required.

When an explosive detonates, it generates a shock wave, which may initiate less sensitive explosives, cause destruction (shell fragments, blast effect, or depression effect), split rocks and soils, or cause formation of a detonation wave. A detonation wave of special geometry (hollow-charge effect) may modify materials by very rapid generation of high pressure; for example, shaped charges, metal hardening, metal-powder compaction, or transformation of crystalline forms. Shaped charges can be applied for the destruction and demolition of large obsolete structures by causing inward collapse. Shaped charges (so-called perforators) are also used in

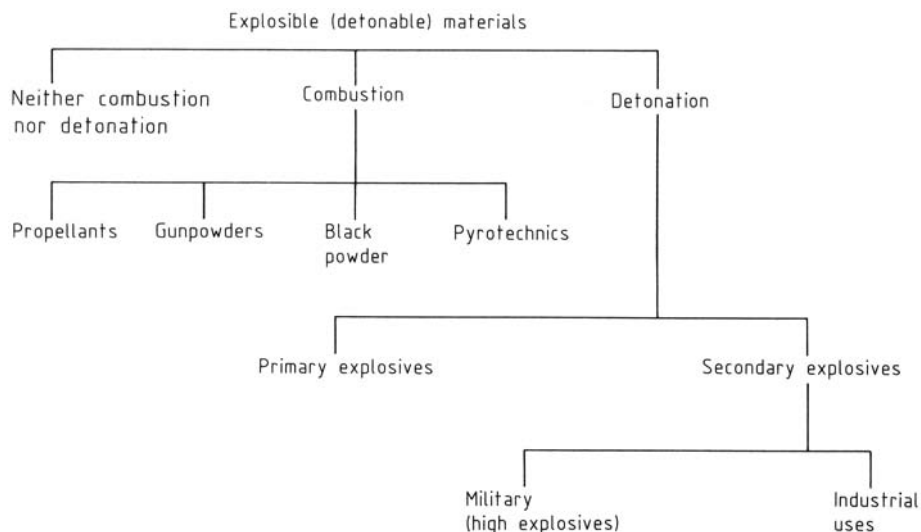

Figure 1. Differentiation of explosible materials

the exploitation of petroleum and natural gas wells to perforate the metal casing of the well and thus allow the influx of oil and gas. A shock wave may be used to transmit signals, e.g., for safety devices or in seismic prospecting.

In general, constraints are related to safety, security, stability, compatibility with other elements of the system, vulnerability, toxicity, economics, and, more recently, environmental and disposal problems [21].

History [1, 4, 88]. Explosives were probably first used in fireworks and incendiary devices. The admixture of saltpeter with combustible products such as coal and sulfur produced *black powder*, already known in China in the 4th century A.C., described in 808 A.C. by Qing-Xu-Zi, and mentioned as a military gunpowder in a book published in 1044. The use in shells during the Mongolian wars around 1270 and a severe explosion in a factory in 1280 were described. The first correct description of the phenomenon of shock waves in air seems to be in a book by the scientist Song-Ying-Xing in 1637. Around 1580 first descriptions in Europe are known (siege of Berg-op Zoom). However, the difficulties of initiation upon impact against the target were not overcome until 1820 when *fulminate caps* were developed. In the early 1600s, black powder was used for the first time to break up rocks in a mine in Bohemia. This technique spread

throughout Western Europe during the 1600s. Ammonium perchlorate was discovered in 1832.

The development of organic chemistry after 1830 led to new products, although their explosive properties were not always immediately recognized. These include nitrocellulose and nitroglycerin.

The very important contributions of ALFRED NOBEL (1833 – 1896) include the use of mercury fulminate in blasting caps for the safe initiation of explosives (1859 – 1861), the development of *dynamites* (by chance NOBEL found that when nitroglycerin was mixed in a ratio of 3:1 with an absorbent inert substance like Kieselgur (diatomaceous earth) it became safer and more convenient to handle, and this mixture was patented in 1867 as Dynamite), and the addition of 8% nitrocellulose (gun cotton) to nitroglycerin (Gelignite or blasting gelatine, 1876).

Many new products were developed between 1865 and 1910, such as nitrated explosives, mixtures in situ of an oxidizer and a fuel, explosives safe in the presence of firedamp, chlorate explosives, and liquid oxygen explosives. Organic nitro compounds for military uses included tetryl, trinitrophenol, and trinitrotoluene.

Between the two world wars, RDX, pentaerythritol tetranitrate (PETN), and lead azide were produced. After 1945 cyclotetramethylenetetranitramine (HMX), 1,3,5-triamino-2,4,6-trinitrobenzene (TATB), and hexanitrostilbene (HNS)

were developed (see Chap. 5), as well as “fuel – air explosives”. Ammonium nitrate – fuel oil (ANFO/ANC) explosives, slurries, and emulsion explosives were developed for industrial uses; some were improved by adding glass bubbles (microspheres), micropores, and/or chemical gassing.

In the 1880s BERTHELOT described the phenomenon of *detonation*. About the same time the hollow-charge effect was discovered, and the foundations of the hydrodynamic theory of detonation were established. In 1906, the first accurate measurements of velocities of detonation were made. After World War II, the science of detonation was further developed and perfected [17].

Recently, new explosive compositions of low vulnerability (LOVA = low vulnerability ammunitions) are being developed. Major efforts are being made to use predicted properties (e.g., density, ΔH_f , sensitivity, thermal stability) to avoid unnecessary experiments [18, 19, 95, 103].

2. Physical Properties and Chemical Reactions

2.1. Detonation

The detonation process needed for most uses is characterized by a shock wave that initiates chemical reactions as it propagates through the explosive charge. The shock wave and reaction zone have the same supersonic velocity; a fraction of the chemical energy is used to support the shock.

2.1.1. Ideal Detonation

A model of ideal detonation (ID) is shown in Figure 2, with steady flow to the end of the reaction zone.

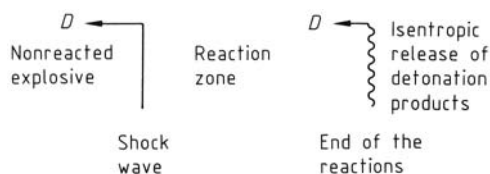

Figure 2. Ideal detonation

Stationarity requires the plane corresponding to the end of the reactions to be locally sonic. This condition, termed the Chapman – Jouguet (CJ) condition [23, 24], yields the relation $D = u + c$ needed to solve the equations of conservation of flow (where D = detonation velocity, u = particle velocity, and c = sound velocity).

The structure of the reaction zone of the ID plane detonation can be ignored, and the mechanical and thermodynamic data can be calculated by solving equations between the non-reacted and fully reacted states. The description of the ideal detonation is given by the model [25–27] represented in Figure 3 by the $p - V$ plane (Fig. 3 A) and the pressure p vs. distance x profile at a given instant of time (Fig. 3 B). This model relates the explosive at rest (V_0), the shocked nonreacted explosive [ZND spike (*)], and the end of the reaction zone [CJ plane (°)]. This model has been experimentally ascertained [28].

In Figure 3 A the three states are located on a straight line (Rayleigh line), with slope equal to $-D^2/V_2^0$. The loci of the shocked states are termed Hugoniot curves: H_0 for the unreacted explosives, and H for the completely reacted explosives.

Some relations at the CJ plane can be expressed as a function of D and the polytropic coefficient of the detonation products:

$$\Gamma = \left(\frac{\partial \log \hat{p}}{\partial \log V} \right)_s$$

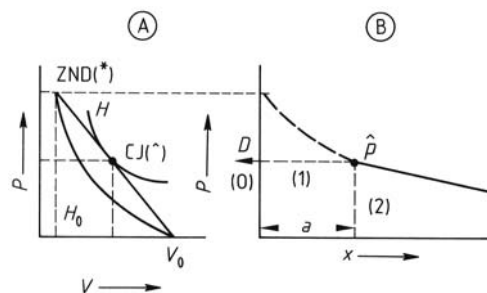

Figure 3. Development of the ideal detonation A) The $p - V$ plane; B) The pressure vs. distance profile; p pressure; V specific volume; D detonation velocity; H_0 Hugoniot curve of nonreacted explosives; H Hugoniot curve of reaction products; (0) explosive at rest; (1) reaction zone of length a , an arbitrary quantity; (2) isentropic release of the detonation product

The notation $()_s$ represents the derivative along the isentrope at the CJ point.

$$\hat{u} = \frac{D}{\Gamma+1} \hat{p} = \hat{q}_0 \frac{D^2}{\Gamma+1}$$

$$\hat{c} = \frac{\Gamma}{\Gamma+1} D \hat{q} = \hat{q}_0 \frac{\Gamma+1}{\Gamma}$$

where $q = \text{density}$

These relations are valid for most condensed organic explosives $\Gamma \approx 3$, with the assumptions that $p_0 = 0$ and $u_0 = 0$.

2.1.2. Deflagration and Detonation

In a thermodynamic diagram such as Figure 3 A, there is another point that satisfies the Chapman – Jouguet condition in the region $p < p_0$ (not drawn in the figure). It represents the Chapman – Jouguet deflagration, in contrast to the detonation:

Detonation	Deflagration
$\hat{p} > p_0$	$\hat{p} < p_0$
$\hat{U} > 0$	$\hat{u} < 0$
$\hat{V} < V_0$	$\hat{V} > V_0$

Unlike the detonation wave, the deflagration wave is subsonic, and consequently a precursor shock is propagated in front of the reaction zone. Its intensity and velocity depend on the chemical energy released and on the boundary conditions; in contrast to detonation, a specific explosive does not provide a unique solution for deflagration.

A precursor shock that is strong enough can, in addition to compressing the explosive, also heat it sufficiently to initiate reactions just behind its front; a progressive buildup of a completely stationary process identical with the ZND model of the detonation is observed. Consequently, a detonation is equivalent to a shock followed by a deflagration.

2.2. Prediction of Detonation Data

2.2.1. Complete Calculation [29]

The quantities D , \hat{p} , \hat{u} , \hat{V} , and \hat{T} in the Chapman – Jouguet state are needed to evaluate further the

effectiveness of the explosive on the surroundings in a given action. The calculation of these quantities requires the equation of decomposition, the heats of reaction, and an equation of state for the reaction products, which may be theoretical (virial expansion) [30, 31], semiempirical [32], empirical [33], or a constant Γ law. In addition, the equilibrium constants for the reaction given as a function of V and T are needed.

For organic explosives, the distinction between oxygen-positive or weakly oxygen-negative explosives, which give only gaseous products, and the strongly oxygen negative explosives, which also give free carbon, is important. In fact, the assignment to one class or the other is determined by the values of the equilibrium constants for (\hat{V}, \hat{T}) determined after a first calculation.

In as much as (\hat{V}, \hat{T}) are a function of the loading density q_0 , some explosives, for instance, pentaerythritol tetranitrate (PETN), produce free carbon at high loading densities and only gaseous products at moderate values of q_0 . Because of the complexity of the calculation, the number and formulation of the equations depend on the final result.

The thermochemical equations are solved with *a priori* (V, T) pairs to give gas product composition. The mechanical equations are then applied at the Chapman – Jouguet plane with the geometric condition represented on Figure 3 A: at the CJ point, the isentropic and the Hugoniot curves have the same tangent, with a slope equal to $-D^2/V_2^0$.

2.2.2. Approximation Methods

A first prediction of the CJ data can be given by using methods valid for condensed explosives.

Chemical Potential. For many organic explosives, D and \hat{p} can be expressed simply as a function of a parameter Φ defined as [34]:

$$\Phi = N\sqrt{\bar{M}_r Q}$$

N	=	number of moles of gaseous products per gram
\bar{M}_r	=	average molecular mass of these products, g/mol
Q	=	enthalpy of the explosive minus the enthalpy of the products, J/g

The calculation of Φ is made under the assumption that:

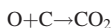
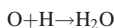

i.e., the formation of water is considered before the formation of carbon oxides.

The following relations are then proposed:

$$\begin{aligned} D &= A(1+BQ_0)\sqrt{\Phi} \\ p &= K Q_0^2 \Phi \end{aligned}$$

A good fit with experimental data is found for organic explosives by setting

$$A = 1.01 \quad B = 1.3 \quad K = 15.58$$

This method, which requires only knowledge of the equation of decomposition, is useful for comparing organic explosives.

Rothstein Method. An empirical correlation has been found between the detonation velocity D and a parameter F , which is a function of the explosive molecule [35].

$$D(Q_0) = \frac{F-0.26}{0.55} - 3(Q_{TM} - Q_0)$$

Q_{TM} = theoretical density

This correlation applies to both organic nitro and fluorinated nitro explosives.

$$F = 100 \frac{n(O)+n(N)+n(F) - \left(\frac{n(H)-n(HF)}{2n(O)} \right)^*}{M_r} + 100 \frac{\frac{A}{3} - \frac{n(B/F)}{1.75} - \frac{n(C)}{2.5} - \frac{n(D)}{4} - \frac{n(E)}{5}}{M_r} - G$$

where $n(F)$, $n(HF)$, and $n(B/F)$ are the elemental terms for fluorinated explosives, and where $G = 0.4$ for each liquid explosive component, $G = 0$ for solid explosives, and $A = 1$ if the compound is aromatic; otherwise $A = 0$. * If $n(O) = 0$ or if $n(HF) > n(H)$, this term = 0.

For 1 mol of composition:

- $n(O)$ = number of oxygen atoms
- $n(N)$ = number of nitrogen atoms
- $n(H)$ = number of hydrogen atoms
- $n(F)$ = number of fluorine atoms
- $n(HF)$ = number of hydrogen fluoride molecules that can form from available hydrogen
- $n(B/F)$ = number of oxygen atoms in excess of those available to form CO_2 and H_2O or the number of fluorine atoms in excess of those available to form HF
- $n(C)$ = number of oxygen atoms doubly bonded to carbon as in a ketone or ester
- $n(D)$ = number of oxygen atoms singly bonded to carbon as in $C-O-R$ where $R = H, NH_4, C$, etc.
- $n(E)$ = number of nitrate groups existing as a nitrate ester or as a nitric acid salt such as hydrazine mononitrate

Molecular masses and atomic composition for explosive mixtures must be derived as sums of mass-average molecular mass and of elemental mole fractions. The prediction of the detonation velocity is ca. 95 % accurate.

2.3. Nonideal Detonation Waves and Explosives

A detonation wave is nonideal if the geometry and dimensions of the charge are such that the reaction zone is affected by lateral shock or rarefaction waves. Consequently, the nonideality depends strongly on the dimensions of the charge and the explosive composition characterized by a given reaction zone length.

An explosive composition consisting of components with different reaction kinetics does not satisfy the ideal detonation model, which assumes all the exoenergetic reactions to be completed simultaneously in the sonic Chapman – Jouguet plane. Such compositions are nonideal explosives. The ideal detonation model applies only as an approximation to most multicomponent explosives; however, with data on reaction kinetics under pressure often lacking, calculations are commonly based on the ideal detonation model.

2.3.1. Nonideal Explosive Compositions

An example of an organic explosive with a metallic nonexplosive additive is a dispersion of aluminum grains or flakes in a cast organic explosive. The process sequence is shown in Figure 4. The energy effectively supporting the detonation wave has been delivered at time t_A . The absorption of energy by aluminum reduces p and D , but the late combustion of the aluminum allows the pressure to be sustained behind the CJ plane, thereby increasing the total impulse transmitted to the surroundings.

The possible sequence of an organic explosive (a) with a negative oxygen balance cast or pressed with a binder containing oxygen (b) is shown in Figure 5. The relatively slow decomposition of the binder produces oxygen gas, which shifts the reaction of the organic explosive toward better oxygen balance, thus increasing energy production.

A typical example of a mixture of two explosive components with different reaction kinetics is a mixture of trinitrotoluene (TNT) and ammonium nitrate (AN). The slower reaction of AN produces energy and an excess of oxygen, which shifts the equilibrium of the TNT reaction to a higher energy release. Because the detonation of the nonideal explosives involves heat transfer

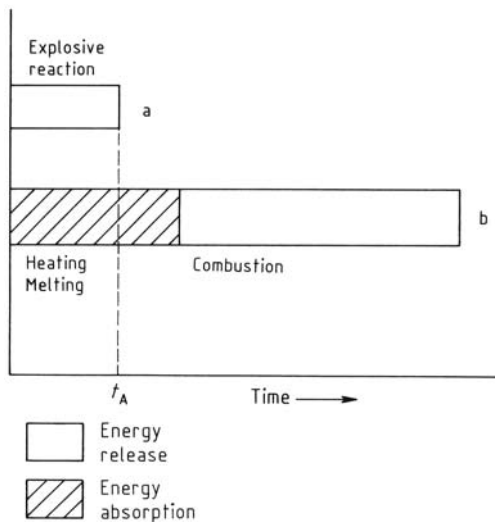

Figure 4. Sequence of reactions: explosive and combustible additive
 a) Cast organic explosive; b) Aluminum grains or flakes

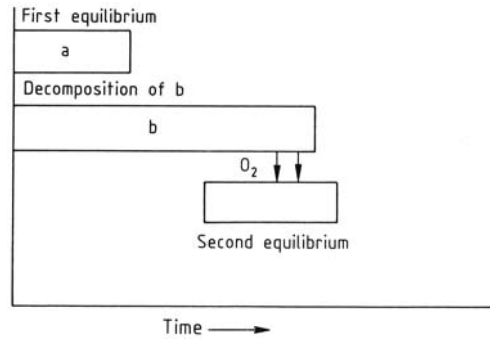

Figure 5. Sequence of reactions: explosive and oxygen-rich binder
 a) Negative-oxygen-balance explosive; b) Oxygen-containing binder

between components, the specific surface areas become important. Moreover, because the total reaction zone is relatively long, detonation depends on the dimensions of the charges.

2.3.2. Detonation of Cylindrical Cartridges

In the detonation of cylindrical cartridges, the reactive flow is two-dimensional, stationary, and relatively easy to model. Many military or engineering applications use cylindrical geometry.

The basic phenomenon is the interaction of the inwardly propagating rarefaction fan, originating at the outer surface as it is reached by the shock wave, with the reaction zone. The first consequence of this interaction is freezing of the reactions by cooling, which reduces the released energy. A second effect is a curvature of the detonation front and a loss in energy through a diverging flow. The reaction zone length and the radius of the cartridge are two quantities that play opposite roles in the process.

The experimental determination of the detonation velocity as a function of the diameter produces a curve limited in two ways:

1. As the diameter increases, the detonation velocity D approaches a constant value D_i equal to that of the ideal detonation wave.
2. Below a given diameter d , called the critical diameter, d_{cr} , the detonation is no longer self-supporting and fails.

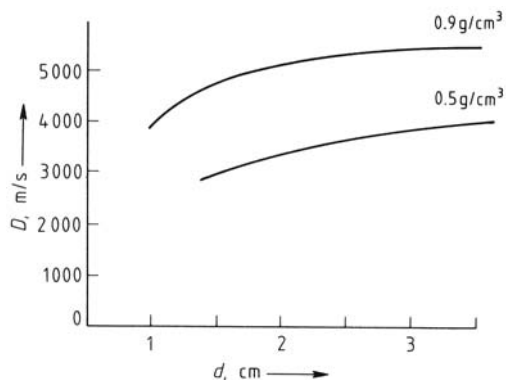

Figure 6. Detonation velocity D vs. diameter d for two densities Q_0 of 60 wt% RDX - 40 wt% TNT

Many analytical expressions $\frac{D}{D_1}(d)$ have been proposed in which the explosive is characterized by its ideal reaction zone length. The function $D(d)$ and the critical diameter d_{cr} depend on both the length and the structure of the reaction zone, i.e., on factors that affect this zone, such as the loading density Q_0 , grain size g , initial temperature t_0 , and composition, especially in the case of mixtures.

As an example of the effects of these factors on ideal explosive compositions, the influence of Q_0 is shown in Figure 6 for the conventional military composition 60 RDX/40 TNT (composition B) [36]. In the case of energy-rich explosives, the effect of the cylinder diameter increases with decreasing density, whereas the critical diameter decreases with increasing density and increasing temperature [37]. The influence of mean grain size, e.g., that of powdered TNT, is shown in Figure 7 [29], and most nonideal explosive compositions and some pure explosives exhibit a particular behavior (see Chap. 6).

2.3.3. Low- and High-Order Detonation Velocity

Some explosives exhibit two different detonation velocities, depending on the diameter of the cartridge and the initial ignition energy. Such explosives always have a relatively low energy and loading density, with great sensitivity to

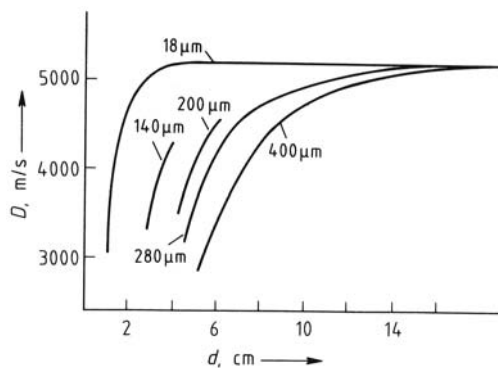

Figure 7. Detonation velocity D vs. diameter d for several grain sizes g of powered TNT

shock waves [36]. Conventional examples are the dynamites and highly porous explosives [38].

The high sensitivity to shock waves tends to allow the detonation to be sustained. This is true even when the development of the reactions is seriously limited by the size of the cartridge. Thus, under steady conditions, a state of shock plus reaction would correspond to that appearing in a transient regime in the buildup of heterogeneous explosives to detonation.

2.3.4. The Effect of Confinement

Confinement usually delays the arrival of the expansion waves on the axis. A confined charge is equivalent to a charge having a large diameter. However, two anomalous effects should be noted: if the velocity of sound in the confinement exceeds the detonation velocity for the given diameter, a foreshock is propagated ahead of the wave. This foreshock can accelerate the wave (increase the density) or stop the detonation, i.e., desensitize a porous explosive by compaction, the explosive becoming homogeneous. An analogous desensitizing effect can be generated if there is an air gap between the explosive and the container. The expanding reaction products adiabatically compress the porous explosive. This effect can stop the detonation of mining charges embedded in boreholes (so-called dead pressing process, especially observed in emulsion explosives).

2.4. The Buildup of Detonation

2.4.1. Combustion – Deflagration – Detonation Transition (DDT)

Deflagration can generate a shock wave, which is propagated in the unreacted medium, and if strong enough, can initiate reactions and become a detonation wave. This transition can occur only if the explosive charge is confined or is of such a size that expansion waves do not prevent formation of a shock wave. Accident reports have shown that DDT affects a variety of explosives and propellant charges.

However, different phenomena, which depend on the mechanical properties of the medium, may occur [39, 40]: if the explosive is porous or exhibits poor mechanical behavior, the gas formed and subjected to pressure is injected between the grains or into cracks, increasing the combustion surface. The resulting acceleration stops only when detonation occurs. The path versus time of the observed ionization front is continuous. In the case of explosives stiff enough to withstand an elastic wave, a steady deflagration develops as soon as the pressure makes the medium impervious to the gas. The transition to detonation occurs as the pressure of the gas formed behind the deflagration zone becomes high enough to generate a shock wave. Detonation occurs when the shock wave reaches the front of the deflagration wave. As a consequence, a discontinuity is observed in the path versus time of the ionization front.

2.4.2. Shock-to-Detonation Transition (SDT)

If the end of an explosive charge is subjected to a shock wave, the steady detonation appears only at a distance s and with a delay τ inside the explosive charge [41]. For a given composition, s and τ are inversely proportional to the intensity of the shock wave. There are two SDT processes: one for homogeneous (for instance, a liquid) and one for heterogeneous composition.

Homogeneous Explosives. The shock wave (a) in Figure 8 propagated at constant velocity initiates decomposition reactions that are first

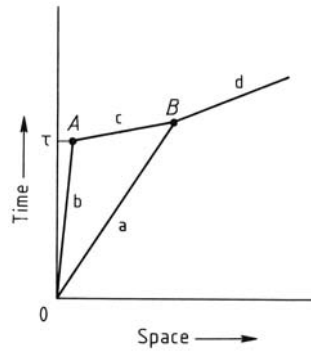

Figure 8. Detonation buildup (SDT), homogeneous explosive

completed along the entrance side (b) at time τ , the detonation appearing at point A. The detonation wave (c) travels in a compressed medium heated by shock wave (a). Therefore, the detonation wave (c) travels with a velocity exceeding the normal detonation velocity, which is attained at point B (wave d) as soon as wave c has reached wave a.

Heterogeneous Explosives. In Figure 9, the shock wave (a) is gradually accelerated by the energy released upon its passage. Its acceleration ends with the appearance of a detonation wave at point B. This wave is characterized by its luminosity, as seen on optical records. Sometimes a second wave starts from point B and moves backward in the explosive, which has reacted only partially (retonation wave). The macroscopic analysis can be explained by the

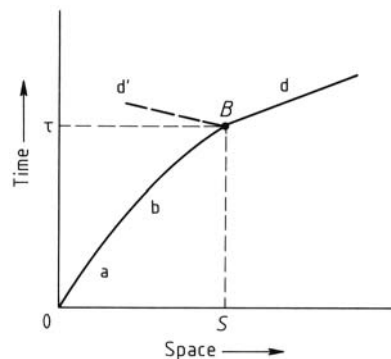

Figure 9. Detonation buildup (SDT), heterogeneous explosive

microscopic heterogeneities of the explosive [42].

The energy of the shock wave is converted into heat energy by the implosion of occluded gas bubbles, the impact of microjets, or the adiabatic shearing of the powder grains. All the observations allow for two successive phases, ignition and buildup, that are accommodated by numerical models assuming inward or outward combustion of the grains [43].

2.4.3. Shock and Impact Sensitivity

The sensitivity of the explosives to an applied load is measured by the maximum load at which no detonation occurs, or at which there is a 50% occurrence of detonation, i.e., a 50% chance of failure. The sensitivity to shock loading depends on the pressure p^* and its action time τ^* . Sensitivity is defined with the aid of the curve $p^*(\tau^*)$, which separates detonation points from failure points.

For a variety of explosives and for a certain pressure range, the sensitivity is defined by the relation $(p^*)^2 \tau^* = \varepsilon$, where ε is a constant that depends on the composition and exhibits the dimension surface energy per unit area [44].

Figure 10 shows that the concept of the energy threshold is an acceptable approximation for solid-state compositions [45]. For liquid explosives, which exhibit different behavior, the relation $\tau^*(p^*)$, based on an Arrhenius-type kinetic

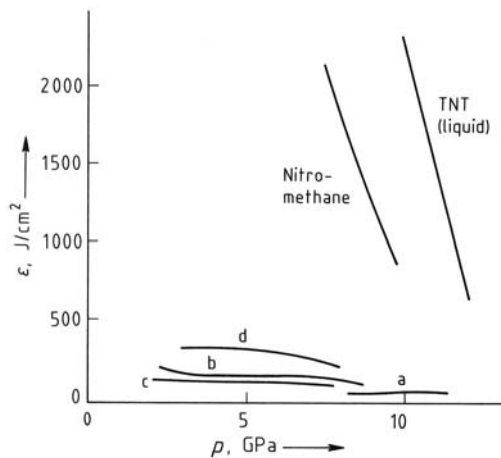

Figure 10. Initiation energy threshold vs. shock pressure
a, b) HMX plus binder; c, d) Cast RDX compositions

theory (with initial temperature T^* expressed as a function of pressure p^*) accurately reproduces the experimental findings. The critical time τ^* is equal, for a given shock pressure, to the time of the shock-to-detonation transition (see Fig. 8). Except for primary explosives, the sensitivity to shock-wave action and the shock-to-detonation transition are both dependent on the homogeneity of the composition. Sensitivity is affected by grain size [104] and internal grain defects [105]. The reaction of an explosive to impact loading depends on several factors. If the projectile is a large plate, the reaction is identical with that observed in the preceding case: the shock wave induced by the impact depends on the velocity and acoustic impedance, whereas the action time is proportional to the plate thickness. In tests of sensitivity to shock-wave action, the impacting plates are driven by explosives. If the projectile is a small sphere or cylinder, the interaction with the target becomes complex [41]. If the shock wave cannot induce a shock-to-detonation transition, it degenerates into an adiabatic compression. Frictional and shearing effects can cause ignition. Finally, a phenomenon analogous to the deflagration-to-detonation transition (see Section 2.4.1) is observed, in which the mechanical properties of the explosive play a part.

2.5. Classification of Explosives

For many years the behavior of cylindrical cartridges, as described in Section 2.3.2, was regarded as typical of ideal explosives. A detailed analysis has shown, however, that classification of explosives into two groups is possible, taking into account the influence of the loading density Q_0 on the detonation velocity as a function of the cartridge diameter and the critical diameter [46].

The first group includes a variety of organic explosives: TNT, RDX, HMX, and their mixtures (see Chap. 5). The second group includes mixtures of an explosive and a combustible nonexploding constituent (nonideal composition). This group also includes some pure explosives such as hydrazine mononitrate (HN), nitroguanidine (NG), ammonium nitrate (AN), dinitrotoluene (DNT), dinitrophenol (DNP), and ammonium perchlorate (AP). The behavior of the second group is illustrated for ammonium perchlorate in Figure 11.

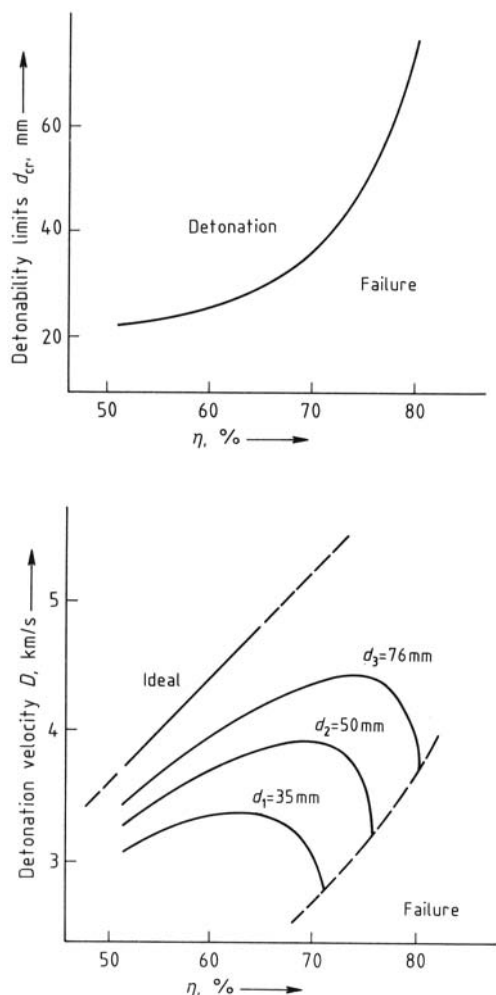

Figure 11. Detonation behavior of ammonium perchlorate; η = percent of the theoretical maximum density

2.6. Functional Groups

Certain groups impart explosive potential.

2.6.1. Nitro Group

The nitro group is present in the form of salts of nitric acid, ONO_2 derivatives (nitrate esters), CNO_2 derivatives (aliphatic or aromatic nitro compounds), and NNO_2 derivatives (*N*-nitro compounds such as nitramines, nitroureas, etc.).

Salts of Nitric Acid. Salts of nitric acid include the alkali metal and alkaline earth metal

nitrate, ammonium nitrate, and the nitrates of methylamine, urea, and guanidine. These are usually low-density, water-soluble, sometimes hygroscopic compounds. With the exception of some salts of hydrazines, e.g., triaminoguanidine and hydrazine nitrates, they are insensitive to impact and friction.

O-Nitro Derivatives, Nitrate Esters (RONO_2). The low molecular mass representatives are liquids or low-melting solids. They are sensitive to impact when the number of carbon atoms and $-\text{ONO}_2$ groups are equal or nearly equal. Densities are in the medium range, except for symmetrical molecules such as pentaerythritol tetranitrate (PETN). Heat stability is moderate; they are subject to hydrolysis and autocatalytic decomposition.

C-Nitro Derivatives (CNO_2). Aliphatic and cycloaliphatic nitro compounds differ greatly from the aromatic and heteroaromatic series. Members of the first group have limited explosive properties, except when the number of NO_2 groups equals or exceeds the number of carbon atoms, as in some *gem*-dinitro compounds and derivatives of nitroform, $\text{HC}(\text{NO}_2)_3$. The latter are often shock-sensitive, with limited heat stability. The compounds $\text{RCF}(\text{NO}_2)_2$ are stable to heat and rather insensitive [6, 7]. Members of the second group containing two or three NO_2 groups per ring are valuable; they are often dense and insensitive to impact, with good hydrolytic and thermal stability.

N-Nitro Derivatives (NNO_2). *N*-Nitro derivatives are often difficult to synthesize. They exhibit high densities and detonation velocities, with some sensitivity to impact. RDX and HMX are representative.

2.6.2. Other Groups

Organic chlorates and perchlorates, peroxides, metal salts of some organic compounds (acetylides and nitronates), and some organic compounds with three-membered rings or chains of nitrogen atoms or triple bonds have only limited application, except as primary explosives. Most are very dangerous to handle.

Nitroso (NO) compounds are usually unstable. So-called hexanitrosobenzene is an exception; however, it is actually not a nitroso compound but a furoxan derivative (benzotrifuroxan). It is of interest because it is free of hydrogen (zero-hydrogen explosive). Other furoxanes and also furazanes have explosive properties [89].

The difluoroamine group imparts explosive character, increased density and volatility, a lower melting point and detonation velocity, and often much higher impact sensitivity. These compounds resemble primary explosives.

Many metal azides are primary explosives. Some organic azido derivatives are being studied because of their high density and stability. However, polyazido compounds can be very sensitive.

3. Application

3.1. Energy Transfer from the Explosive to the Surroundings

The energy available in the gaseous reaction products is transferred to the surroundings by shock waves. The mechanical effects depend on the geometry of the charge and the surroundings, on the distance from the charge, and on the acoustic impedance of the media. The explosive energy is used either to create compression and tension for engineering applications or to accelerate projectiles for military applications.

3.1.1. Shock and Blast Waves

The highest dynamic pressures are produced at the exit end of the charge, where the detonation shock is transferred to the inert material. The shock pressure is a function of the shock impedance. It is defined by the so-called shock polar curve of the pressure (p) vs. particle velocity (u). By a graphical method (Fig. 12) the induced pressure can be determined at the intersection of a shock polar curve with the detonation gas-product curve passing through the CJ point.

Even higher pressures can be obtained by using converging geometries or, indirectly, by a two-stage device. The explosive accelerates a thin metal plate, which generates an intense shock in the solid specimen as it strikes it in free

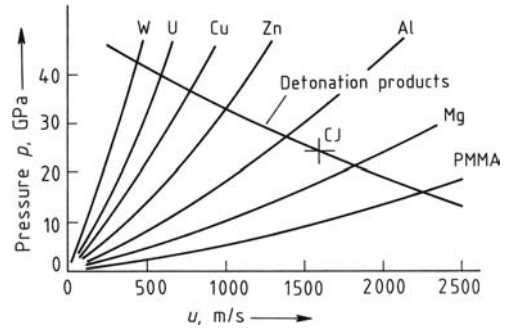

Figure 12. Determination of shock pressure p and particle velocity u induced in an inert material by an explosive; PMMA = poly(methyl methacrylate)

flight. During wave propagation in the surrounding medium, the intensity of a shock wave decreases and the pressure profile changes. At a given distance from the charge, compression alternates with tension. The mechanical effects are a function of the maximum pressure and of the positive and negative impulses comprising the so-called blast wave. The maximum and minimum pressures are represented in Figure 13 as a function of the reduced distance $R/m^{1/3}$ from the charge.

3.1.2. Casing and Liner Acceleration

A casing or liner in contact with an explosive charge is accelerated by a three-step process:

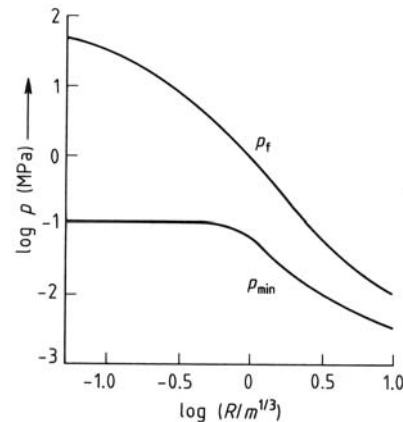

Figure 13. Front pressure p_f and minimum pressure p_{\min} in air vs. reduced distance $R/m^{1/3}$ from TNT in air, where R is the distance in meters and m the mass in kilograms

1. u_1 given by the shock wave
2. $u_2 \approx 2 u_1$ given by reflection of the shock wave in a release wave at the free surface
3. u_3 given by the further expansion of the gaseous detonation products

The Gurney formula gives an approximate u_3 for a casing filled with an explosive characterized by the quantity E , which is given in J/kg [47]:

$$u_3(m/s) = (2E)^{1/2} \left(\frac{M}{C} + \alpha \right)^{-1/2}$$

where

M = mass of the casing, kg

C = mass of the explosive, kg

$\alpha = 0.5$ for a cylindrical charge and

$\alpha = 0.6$ for a spherical charge

3.2. High Compression of Solids

Explosives provide the most powerful means for compressing solids in spite of the fact that at high pressure the heating limits the volume reduction.

Production of New Crystal Phases. The high pressure generated by shock waves may be used to transform one crystal phase into another (polymorphic transformation). The best-known example of this technique is the transformation of graphite into diamond. Unfortunately, the short duration of the shock limits this technique to the production of small crystals used as abrasives.

Powder Compaction. The compression of powders by shock waves produced by explosives creates high pressures and temperatures simultaneously, resulting in grain welding. The main problem, which has been solved only recently, is the explosion caused by the interaction of release waves, which follow the shock; special geometries are required [48]. Rapidly solidified amorphous and metastable microcrystalline materials and ultrahigh-strength ceramics are expected to be produced by this technique.

Shock Hardening. The detonation of a thin sheet of explosive covering a piece of steel creates great surface hardness by a sequence of rapid compression, heating, and cooling.

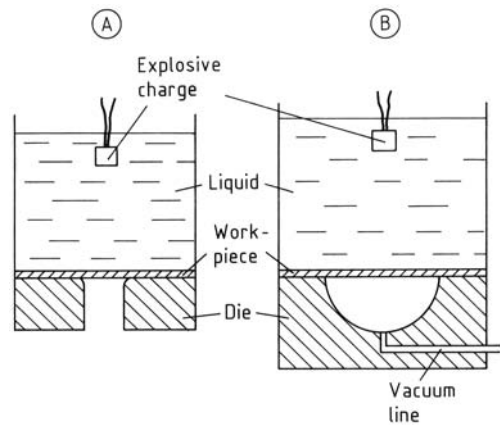

Figure 14. Setups for metal forming
A) Free forming; B) Bulkhead forming

3.3. Metal Forming and Welding

The detonation of an explosive charge is used to form a metal plate; the shock wave is moderated by a liquid transmitting medium (Fig. 14). Techniques of free forming (Fig. 14 A) or bulkhead forming (Fig. 14 B) may be used.

A grazing detonation may weld two metal plates (even different metals such as titanium on steel or aluminum on copper) with diffusion of metal through the interface (Fig. 15) [49]. The required collision velocity v_c depends on the materials and the types of explosives used. This process is called explosive welding or metal cladding.

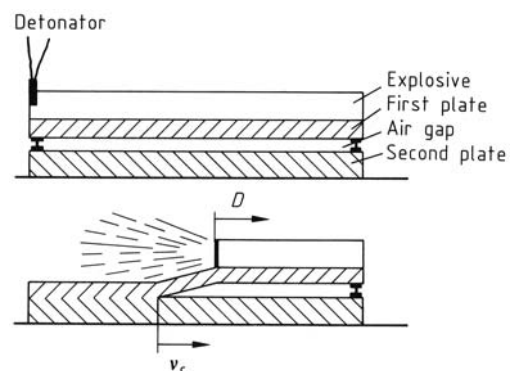

Figure 15. Explosive welding or cladding

3.4. Rock Blasting [36]

In rock blasting the explosive systems are placed in blast holes, which are usually drilled in defined distances and angles into the bench and/or the wall of the quarry. With strong confinement, which is usually achieved by stemming the bore-hole, most of the explosive energy is usefully employed, even though some of it is released by afterburning. Depending on the specific requirements of the quarry, the geological/petrological conditions, the required rock fragmentation, the cost effectiveness, and the environmental parameters (ground vibration, dust, noise, air blast), the blasting specialists determine which blasting system should be applied to optimize the overall performance and results. This refers to selection of the correct type of explosives, for example, cartridged products such as dynamites or emulsions; bulk emulsion explosives which are manufactured from non-explosive substances on the bench by so-called mobile emulsion manufacturing units (MEMUs) and pumped directly into blast holes on demand; ANFO in packaged form or from bulk trucks, and an appropriate initiation system (electrical, nonelectrical, or electronic detonators, detonating cords, and delay relays or combinations thereof). Various types of wedge cuts are used for underground blasting operations.

3.5. Perforators, Shaped or Hollow Charges

An explosive can be used to produce a thin, high-speed metallic projectile capable of perforating armor [50]. Nonmilitary applications include oil (perforators) and the demolition of structures.

A cavity in the explosive (Fig. 16) is lined with a metal, usually copper. The detonation divides the liner into two parts that move along the axis at different velocities. Most of the mass of the liner forms the so-called slug at a velocity of several hundred meters per second. The remainder forms a thin projectile which is elongated because of the difference of velocity between the first formed elements near the apex (u_{jet} max. $\approx 8000 - 11\,000$ m/s) and those formed last (u_{jet} min. = $1500 - 2000$ m/s). The ultimate length of the projectile depends on the ductility of

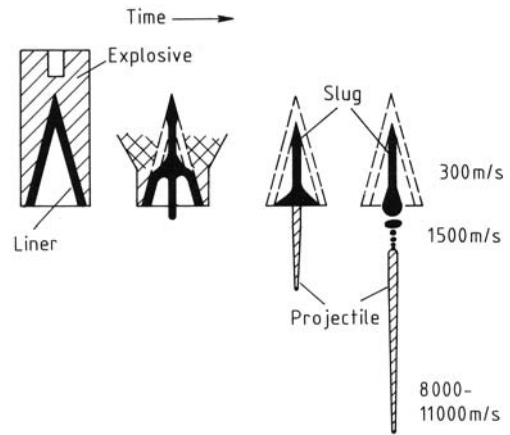

Figure 16. Projectile formation

the liner and can be > 10 times the diameter of the charge.

When the projectile strikes a solid or liquid target, it drills a deep, narrow hole. The hole depth P is given approximately by the expression

$$P = L \sqrt{\frac{\rho_j}{\rho_t}}$$

where L is the length of the projectile and ρ_j and ρ_t are the densities of the projectile and target.

4. Primary Explosives

Under low-intensity stimulus of short duration, primary explosives, even in thin layers, decompose and produce a detonation wave; the activation energy is low. The stimulus may be shock, friction, an electric spark, or sudden heating. The deflagration – detonation transition occurs within a distance often too short to be measured. The released energy and the detonation velocity of primary explosives are small. Their formation is often endothermic.

The main function of primary explosives is to produce a shock wave when the explosive is stimulated by percussion, electrically, or optically (laser), thus initiating a secondary explosive. Primary explosives are the active detonator ingredients. Some are used in primer mixtures to ignite propellants or pyrotechnics. Because of their sensitivity, primary explosives are used in

Table 1. Properties of primary explosives

Property	Lead azide, pure	Silver azide	DDNP	Lead styphnate	Tetrazene
Crystal density, g/cm ³	4.8	5.1	1.63	3.0	1.7
Detonation velocity, km/s at density	6.1*	6.8*	6.9	5.2	
	4.8	5.1	1.6	2.9	
Impact sensitivity, Nm	2.5 – 4	2 – 4	1.5	2.5 – 5	1
Friction sensitivity, N	0.1 – 1		20	8	10
Lead block test, cm ³ /10 g	110	115	325	130	130
Explosion temperature, ** °C	345	290	195	265 – 280	160

*Theoretical.

** After 5 s.

quantities limited to a few (milli)grams, and are manufactured under special precautions to avoid any shock or spark. To be used in industry, primary explosives must have limited sensitivity and adequate stability to heat, hydrolysis, and storage. Mercury fulminate, azides, and diazodinitrophenol are among the few products that meet these requirements and that can detonate a secondary explosive. Others, e.g., lead styphnate or tetrazene, initiate burning or act as sensitizers.

Properties of primary explosives are given in Table 1.

Mercury Fulminate [628-86-4], Hg(ONC)₂, M_r 284.65, was first prepared in the 1600s and was used by NOBEL in 1867 to detonate dynamites. It is prepared by the reaction of mercury with nitric acid and 95 % ethanol, in small quantities because the reaction is difficult to control. Mercury fulminate is a gray toxic powder, which lacks the stability for storage. It reacts with metals in a moist atmosphere; in most industrial countries its use has been abandoned.

Lead Azide [13424-46-9], Pb(N₃)₂, M_r 291.26, discovered by CURTIUS (1891) [13], was developed after World War I and is now an important primary explosive. It is produced continuously by the reaction of lead nitrate or acetate with sodium azide in aqueous solution under basic conditions to avoid formation of hydrazoic acid, which explodes readily. The crystal size must be carefully controlled, large crystals being dangerous, by controlling the stirring and by using wetting agents. Demineralized water must be used. With thickeners such as dextrin, sodium carboxymethylcellulose, or poly(vinyl alcohol), purities from 92 % to 99 % are possible, the former containing 3 % dextrin and 4 – 5 % Pb(OH)₂. The lower sen-

sitivity of the 92 % lead azide to impact and friction compared to purer lead azides facilitates detonator loading. Lead azide has good stability to heat and storage. Contact with copper must be avoided because *copper azide* is extremely sensitive; aluminum is preferred. *Silver azide* is used at high temperature or in miniaturized pyrotechnic devices. It is prepared from aqueous silver nitrate and sodium azide.

Diazodinitrophenol [28655-69-8], DDNP, C₆H₂N₄O₅, M_r 210.06, is obtained by diazotizing picramic acid and purified by recrystallization from acetone. It is sparingly soluble in water, nonhygroscopic, and sensitive to impact, but not as sensitive to friction or electrostatic energy. It is less stable to heat than lead azide. It is most often used in the United States.

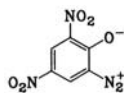

Lead Styphnate [15245-44-0], lead trinitroresorcinic acid, C₆HN₃O₈Pb, M_r 450.27, is produced continuously by the aqueous reaction of the magnesium salt with lead acetate, sometimes in the presence of agents that promote the formation of the correct crystalline form. Especially sensitive to electrostatic discharge, it is most frequently used to sensitize lead azide and in primer compositions to initiate burning.

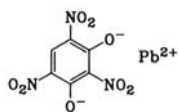

Tetrazene [31330-63-9], $C_2H_8N_{10}O$, M_r 188.07, is obtained by the reaction of sodium nitrite with a soluble salt of aminoguanidine in acetic acid at 30–40 °C. It decomposes in boiling water. Its greatest value is for the sensitization of priming compositions.

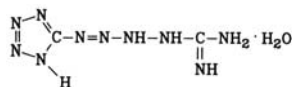

A current trend in research on new primary explosives is to replace compounds containing lead for environmental problem reasons.

5. Secondary Explosives

5.1. Production

Common high explosives are usually made by liquid-phase nitration. The overall mechanism is believed to be ionic, with NO_2^+ generally the reactive species. In some cases, N_2O_4 may be added to a double bond or to an epoxy group. It is also possible to nitrate gas-phase hydrocarbons. The most important nitrating agent is nitric acid (\rightarrow Nitric Acid, Nitrous Acid, and Nitrogen Oxides).

Numerous end products of nitration are soluble in concentrated HNO_3 , and may be recovered by dilution. However, dilution below ca. 55 wt % acid is not economic.

To increase the NO_2^+ content (3 wt % in pure HNO_3), lower the solubility of end products, reduce oxidative side reactions, and facilitate the treatment of spent acids, mixtures of sulfuric and nitric acids (mixed acid) are used. The water content of a mixed acid may be reduced by adding oleum. In 50:50 wt % mixed acid, the nitric acid is ca. 15 % dissociated.

However, sulfuric acid is difficult to remove from products by washing. Furthermore, some substances (e.g., nitramines, nitriles, etc.) are decomposed. Orthophosphoric acid or polyphosphoric acid may be used instead of sulfuric acid; however, these phosphoric acids are more expensive and more difficult to recover.

Mild nitration or nitrolysis can be conducted in mixtures of nitric acid and acetic anhydride or

acetic acid; the reactive species may be $CH_3COONO_2H^+$. Mixtures of nitric acid and acetic anhydride containing between 30 and 80 wt % HNO_3 can detonate [51]. A high concentration of acetic anhydride avoids this danger. More recent nitration methods use N_2O_5 as a solution in pure nitric acid (“nitric oleum”) or in chlorinated solvents (e.g., CH_2Cl_2). Three processes for the production of nitric oleum are in operation or in development [89]:

1. Oxidative electrolysis of a $N_2O_4 - HNO_3$ mixture
2. Ozonation of N_2O_4
3. Distillation of an oleum ($H_2SO_4 + SO_3$) – NH_4NO_3 mixture [90]

Nitric oleum allows yields to be improved and permits some syntheses to be performed that are not possible by other routes; the organic N_2O_5 solutions allow nitration to be performed under very mild and selective conditions [16, 91]. These nitrating agents must be used at their site of production.

Nitration. Reaction is exothermic. Dilution of the nitric and mixed acids with water liberates heat [52]. Normally, nitration is rapid. However, 70–85 wt % nitric acid is also an oxidant, and for this reason the reaction is best conducted continuously to limit the contact time of the product with the reactive medium. If the medium is free of solid particles, a tubular reactor can be used; otherwise, reactors in cascade with efficient stirring are employed. These reactors are made of highly polished stainless steel. Reactors and stirrers must be carefully designed to avoid dead zones and friction with crusts of explosives. Reactors are often provided with a valve that opens quickly to discharge reactants into a dilution vessel in an emergency.

Product Isolation. If a precipitate is not highly sensitive to friction, it may be centrifuged. For safe continuous filtration, the product must be stable in its mother liquor, and the filter design must avoid introduction of the explosive between moving and fixed parts. The precipitate is washed in two stages. The first uses only a small amount of water, which is recovered and mixed with spent acid. The acid is recovered from this mixture.

Purification. Treatment with boiling water is sometimes sufficient to hydrolyze impurities and wash out nitric acid. Crystallization eliminates sulfuric acid and produces the desired grain size. The solvent can be diluted with water or removed by steam distillation. Very fine crystals are obtained by dilution with high-speed stirring or by grinding in water or an inert liquid. A fluid energy mill may also be used. Size separation can be effected by sieving under flowing water or in a classifier. Drying is usually done as late as possible in the process.

Recovery of Spent Acids. Acid recovery in an explosive plant is of great importance in controlling production costs. These acids include 55 wt % HNO₃, 63 – 68 wt % H₂SO₄ from nitric acid concentration, and spent H₂SO₄ containing some nitric acid and nitration products.

To concentrate nitric acid, water is removed by countercurrent extraction with 92 – 95 % H₂SO₄. At the top, 98 – 99 % HNO₃ is produced. At the bottom, 63 – 68 % H₂SO₄ is obtained, which can be concentrated to 93 % by stripping with combustion gases, or to 96 – 98 % by vacuum distillation. Nitric acid can also be concentrated by distillation over magnesium nitrate.

Sulfuric acid is freed of nitric acid and nitro compounds by heating or steam injection.

Pollution Problems. Gaseous pollution may occur during nitrations, with evolution of red nitrous fumes. These can be absorbed in columns by recycling water or dilute nitric acid to provide 50 – 55 wt % acid.

Liquid and solid pollution is created by washing. Usually acids are transferred to decanting and settling basins, where product and other solid particles settle and liquids are neutralized. Some liquid wastes require special treatment; for example, the red liquors from TNT are best destroyed by combustion.

Safety [9, 11]. Accidents caused by detonation are usually very severe. In addition to the normal precautions required in acid handling, the production and use of explosives obviously involves special risks. Loss of life and destruction of property by an accidental explosion must be prevented at all costs, and the detonation of explosives stored near populated areas must be

avoided. Minimum distances between plant and nearby structures are regulated.

The transmission of detonation by pipes or feeding devices must also be prevented by appropriate arrangements. The danger of detonation by an accidental fire can be mitigated by limiting vessel size. Detonations by shock and friction in pipes, pumps, or valves are prevented by suitable measures.

The following principles apply: partition of risks (e.g., specific buildings for specific operations); limitation of risks (limited number of persons present and limited quantities of explosives); and installation of two or three independent safety devices. Some of these measures are taken by the manufacturers under the supervision of professional organizations following government regulations.

5.2. Specific Secondary Explosives

Properties of secondary explosives are given in Tables 2 and 3.

5.2.1. Nitrate Esters

Nitrate esters RONO₂ are prepared from alcohols and nitric acid, which may be mixed with sulfuric or acetic acid. The reaction is reversible:

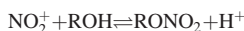

In an anhydrous medium the equilibrium shifts to the right; with dilution, hydrolysis occurs. In 60–80 % HNO₃, the unreacted alcohol may be oxidized. Furthermore, a catalytic effect of the nitrous acids produced causes rapid decomposition of the reaction medium. This decomposition either does not occur or occurs very slowly with an acid concentration below 55 %. Nitrate esters are usually less stable if traces of acid are present. Traces of sulfuric acid are difficult to remove from solid nitrate esters; therefore, mixed acid should not be used for their preparation. Acetic – nitric acid mixtures are used with sensitive or oxidizable alcohols.

Pentaerythritol Tetranitrate [78-11-5], PETN, C₅H₈O₁₂N₄, *M_r* 316.15, is scarcely soluble in 82 % HNO₃ (0.7 wt %). The nitration of pentaerythritol is practically complete in a few seconds and is

Table 2. Properties of secondary explosives

Property	PETN	NG	TNT	HNS	TATB	RDX	HMX	DINGU	NTO	ADN	Sorguyl	CL20 (€)
<i>m_p</i> , °C	141.3	13.5	80.8	318	>452	204	283	260	255	92	190	
Vapor pressure, Pa	0.0011 at 100 °C	1 at 40 °C	14 at 100 °C	decomp. 1.3 × 10 ⁻⁷ at 100 °C	decomp. 0.4 at 175 °C	0.05 at 110 °C	4 × 10 ⁻⁷ at 100 °C	decomp.	decomp.			
Crystal density, g/cm ³	1.77	1.591 ^a	1.654 1.47 ^a	1.74	1.94	1.82	1.907 ^b	1.98 ^c	1.91 ^d	1.83 ^d	2.03 – 2.04	2.04
Detonation velocity at max. density, m/s ^f	8340	7700	6960 at 81 °C	7120	7970	8850	9100	8450	8520	ca. 3900	9300	9300
Critical diameter, mm	0.4			0.4	6 – 8			6 – 8		4 – 8	<1	
Lead block test, 10 g. cm ³	520	520	300			480	480					
Explosion temperature after 5 s, °C	225	220 – 240	470	305	315 decomp. 520 explodes	301	330					

^aLiquid.^bβ form.^cCalculated in some cases.^dα form.^eby x-rays 1.99

Table 3. Impact sensitivity of secondary explosives*

Explosive	Value**
In insensitive	
TATB	> 2.5
TNT	1
Moderately sensitive	
DINGU	0.8
HNS	0.6
NTO	0.8
Sorguyl	0.15 – 0.2
CL20	0.15 – 0.2
Sensitive	
HMX, RDX	0.3
PETN	0.15 – 0.2***
NG	0.1

* Drop-weight impact test [7].

** Based on TNT = 1.

*** Values are dependent on particle size

conducted continuously. Pentaerythritol and HNO₃ (ca. 1:5.5) are fed into a well-stirred, jacketed reactor, with overflow in cascade into a second reactor of the same design. The temperature is maintained below 30 °C. PETN precipitates and may be isolated in one of two ways:

1. In a third reactor the reaction mixture is diluted with water to 55 wt % acid (*c*_{PETN} 0.1 wt %) and filtered. The PETN is washed with water
2. The reaction mixture is filtered immediately and then the 82 wt % spent nitric acid is concentrated, a cheaper process but less safe

Washed PETN is stable. It can be recrystallized by dilution of a hot acetone solution with water, which removes traces of acid and some organic impurities, and crystals of desirable size and flow properties for continuous feed purposes are obtained. Pentaerythritol tetranitrate is fairly stable above 100 °C and in alkaline medium. It is a powerful high explosive, with a small critical diameter, easy to initiate, and sensitive to impact and friction. But that sensitivity depends on the crystal size: PETN is more insensitive if ultrafine or in form of a very big monocrystal. Nanometric PETN was recently obtained by a sol – gel process. It is used in detonators, commercial detonating cord, boosters (with wax), sheet explosives (with an elastomeric binder), and plastic explosives. In a mixture with TNT, it is employed in some warheads and in industrial explosives.

Nitroglycerin [55-63-0], NG, $C_3H_5O_9N_3$, M_r 227.09, unlike PETN, is a liquid at room temperature, totally miscible with HNO_3 of higher than 70 % concentration, sparingly soluble (3 wt %) in 50 % HNO_3 , and sensitive to hydrolysis (any contact with hydrolytic medium must be very short) [53]. It is prepared by continuous two-phase nitration of glycerol in anhydrous mixed acid. The mass ratio of pure anhydrous glycerol ($H_2O < 0.5\%$) and 50 : 50 mixed acid is 1 : 5. The product is washed with aqueous sodium carbonate or bicarbonate.

In the Schmid – Meissner and Biazzzi processes, the reactor is a vessel with overflow and good stirring and cooling. The reactants are fed continuously, while the temperature is kept at 10 – 20 °C. The emulsion produced flows into a separator, which in the Schmid process does not have moving parts. In the Biazzzi process, the separator is conical with peripheral feeding, breaking the emulsion by rotation. The product is washed with alkaline water in columns (Schmid) or in mixer – settlers (Biazzzi).

In the Gyttop process, developed in the 1950s, the feeding of acid and alcohol can be interrupted simultaneously. The key feature is the use of an injector with an axial flow of acid; the alcohol is sucked through the neck with excellent mixing. For good suction and heat absorption, a volume ratio of acid: alcohol of ca. 8 is required; it is maintained by recycling part of the spent acid. The glycerol is heated to 48 °C to reduce viscosity. The emulsion that is formed is cooled to 15 °C, and centrifuged continuously to separate the nitroglycerin from spent acid. The product is emulsified with alkaline wash water by passage through an injector; it is separated and washed again until neutral. The final emulsion can be safely transmitted through pipes. The quantity of nitroglycerin present at any given time can be kept low, and safety is further increased by protective walls and the use of remote control.

Other liquid nitrates are produced by these processes; the Gyttop process requires a liquid alcohol reactant. The spent acid may be purified by heating. Nitroglycerin is used in propellants, gunpowder, and dynamites.

5.2.2. Aromatic Nitro Compounds

The most common nitro-aromatic explosives contain the picryl (2,4,6-trinitrophenyl) group

and are usually obtained by nitration. The Ingold mechanism involves nitronium ion, NO_2^+ ; electrophilic attack occurs with formation of a σ -complex intermediate [22].

The introduction of a second and third nitro group requires increasingly severe conditions, including more anhydrous mixed acids and elevated temperatures (above 100 °C for trinitration).

Some of these aromatic nitro compounds are not used or are abandoned as explosives: among them:

1,3,5-Trinitrobenzene [99-35-4], TNB, benzite $C_6H_3O_6N_3$, $M_r = 213.11$ (I, R = H), attractive as high explosive, cannot be obtained by direct nitration of benzene, but only by indirect syntheses giving an expensive product used only for preparations of fine chemicals.

2,4,6-Trinitrophenol [88-89-1] $C_6H_3O_7N_3$, $M_r = 229.11$ (I, R = OH) TNP, picric acid, melinite, was extensively used in France during World War I because of lack of toluene, but was later replaced by trinitrotoluene (tolite), cheaper and nonacidic. In some ammunitions, ammonium picrate is still used.

2,4,6-Trinitrophenyl-N-methylnitramine [479-45-8] *N*-methyl-*N*,2,4,6-tetranitroaniline, Tetryl, $C_7H_5O_8N_5$, $M_r = 287$ (I, R = $N(CH_3)NO_2$) has been used since 1905, notably for the production of boosters, after lubrication by graphite or calcium stearate. But it is now practically abandoned because some allergic incidents of dermatosis, and replaced mostly by RDX – wax mixtures.

Three nitro-aromatic products with a picryl group remain for use as high explosives: TNT, HNS, and TATB.

2,4,6-Trinitrotoluene [118-96-7], TNT, tolite, $C_7H_5O_6N_3$, M_r 227.13 (I, R = CH_3), is produced by successive nitration of toluene, producing mono-, di-, and finally trinitrotoluenes. The mononitration products are 60 % *ortho*, 35 % *para*, and 3 – 5 % *meta* derivative.

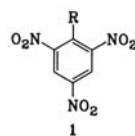

The *o*- and *p*-nitro compounds give 2,4- and 2,6-dinitrotoluenes and then 2,4,6-trinitrotoluene (*meta*-directing effect of NO₂). However, *m*-nitrotoluene does not give the 2,4,6-trinitro derivative; other products are formed that reduce the stability or lower the melting point of the TNT. These impurities can be removed by the so-called selliting process or by fractional distillation of the mononitration products. The *m*- and *p*-nitrotoluenes are used as chemical intermediates, and the *o*-nitrotoluene is further nitrated to TNT. This method gives a product that is more easily purified.

For reasons of safety, quality, and cost, modern high-capacity plants use a continuous process. The solubility of organic products in mixed acids can be quite low, 0.5 – 15 wt %, depending on temperature and sulfuric acid concentration. Nitration is believed to occur in the acid phase. Consequently, the rate of interphase transfer and the intensity of stirring are important.

The plant employs a series of 8 – 16 mixer – settlers. The organic phase is transferred from the preceding settler together with the acid phase from a following or preceding settler (counter-current or parallel nitrators) into a mixer maintained at a constant temperature (50 °C for mono-, 80 °C for di-, and 100 °C for trinitration). Acids may be added to adjust the composition. From the last settler, molten TNT overflows into other mixer – settlers that are used for washing and selliting.

The spent sulfuric acid can be concentrated to ca. 96 % but not to oleum. Using oleum in the process leads to a higher yield, a shorter starting time, and a more rapid reaction; consequently, fewer mixer – settlers are required for a given output, but a use or customer must be found for the spent acid.

Selliting is a process of washing with aqueous Na₂SO₃. A preferential reaction with the unsymmetrical TNT isomers gives deep-red water-soluble products. Selliting is applied to crude molten TNT above 80 °C, but with some losses. A continuous process may also be employed at 50 °C, with TNT suspension produced by cooling an aqueous emulsion with vigorous stirring [54]. The resulting spherules contain pure 2,4,6-TNT at their center, and a mixture of isomers in the outer layer. The use of MgSO₃, rather than Na₂SO₃, has been proposed [55]. The most eco-

nomical treatment of the red spent water from selliting is concentration followed by combustion.

Trinitrotoluene is used alone or mixed with PETN, RDX, or ammonium nitrate. It is also used in some industrial explosives.

Hexanitrostilbene [20062-22-0], HNS, C₁₄H₆O₁₂N₆, *M_r* 450.24, is formed by oxidation of TNT in methanol – tetrahydrofuran solution with aqueous NaOCl [58]:

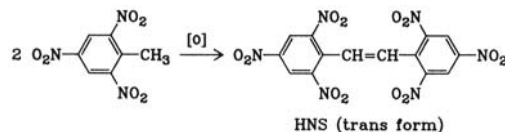

Yields of 40 – 50 % are obtained in a continuous tubular reactor [59, 60]. Hexanitrostilbene can be crystallized from HNO₃ or acetone.

Hexanitrostilbene has the following unusual properties: the presence of 1 % HNS in molten TNT prevents the formation of cracks and crazes during solidification. With its low critical diameter (0.4 mm) it can be used as the core in silver or other metallic explosive cords. It remains stable and explosive over a very wide temperature range (–200 to 250 °C) and is thus usable in space [61].

1,3,5-Triamino-2,4,6-trinitrobenzene [3058-38-6], TATB, C₆H₆O₆N₆, *M_r* 258.15, is obtained by the following sequence:

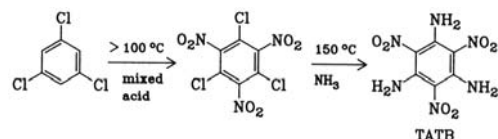

The proximity of nitro groups favors the displacement of chlorine by ammonia. The reaction is conducted under pressure at 150 °C in toluene containing a little water. The product is washed with water to remove NH₄Cl. It has low solubility and is difficult to recrystallize [62, 63]. Although discovered in 1887, it first attracted attention after World War II. Since the 1950s interest has increased because of its thermal stability and outstanding insensitivity. Mixed with HMX and a fluorinated binder, it is used as a booster. It is, however, expensive (ca. 65 \$/kg in the mid-1980s in the USA) because of the

high cost and low availability of trichlorobenzene. Therefore, alternative synthetic routes have been developed. An extensive review of TATB is given in [9].

5.2.3. *N*-Nitro Derivatives

N-Nitro derivatives include primary nitramines RNHNO_2 , secondary nitramines $\text{RR}'\text{NNO}_2$, nitramides, nitroureas, nitrourethanes, and nitroguanidines. There are no general synthetic methods. Sometimes it is possible to nitrate the precursor with HNO_3 alone as with tetryl. Often an *N*-acetyl, *N*-*tert*-butyl, or *N*-nitroso derivative is used as starting material. In some cases, nitric oleum is effective. The nitration of hexamethylenetetramine (hexamine) to RDX and HMX is more complicated.

1,3,5-Trinitro-1,3,5-hexahydrotriazine [121-82-4], $\text{C}_3\text{H}_6\text{O}_6\text{N}_6$, M_r 222.12, cyclotri-methylenetrinitramine, Hexogen, RDX.

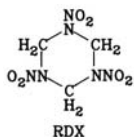

Both RDX and HMX are stable in nitric acid over a wide temperature and concentration range, but are destroyed by aqueous sulfuric acid and are attacked by alkaline substances. Sulfuric acid should not be present during the synthesis.

1,3,5-Trinitro-1,3,5-hexahydrotriazine was first described by the German chemist and pharmacist G. F. HENNING [64]. It is manufactured by nitrolysis of hexamine with nitric acid alone or with acetic anhydride.

The main process, called the Woolwich process, which does not use acetic anhydride, was developed in the United Kingdom and is used there and in France. The raw materials are hexamine and 98 – 99 % HNO_3 free of sulfuric acid. The reaction is complex and not completely understood.

Hexamine dinitrate is probably formed first, followed by intermediates that are oxidized or decomposed, exothermically and often violently, to produce RDX, which precipitates. Large amounts of nitrous gases and CO_2 are evolved

along with water. The process must be continuous with careful control of temperature and flow conditions. The plant consists of three groups of stainless steel cascade-type reactors with efficient stirring and cooling devices (jacket or coil). Nitric acid and hexamine are fed into the first group at a temperature of 20 – 50 °C. The homogeneous mixture overflows from the last reactor into the first one of the second group (the decomposers); this reactor is equipped with a large pipe for the escape of gases and a water feeder. The temperature is maintained between 75 and 82 °C, and water is continuously added to maintain a HNO_3 concentration of 55 wt %. The gases evolved are condensed in towers, producing 50 – 55 wt % HNO_3 , which is reconcentrated. This first decomposer is the key to the operation. Foam must be avoided as well as thick crusts on which the stirrer could scrape, causing an explosion. In the third group of reactors, the suspended product is cooled and then continuously filtered and washed. The resulting RDX contains HMX (1 % max.) and some nitric acid, which can be removed by heating with water at 135 °C for 3 h in an autoclave. The yield based on hexamine is 78 – 80 %.

The RDX can be recrystallized or used directly, after desensitizing by wax or 10 % TNT to permit drying and transportation. Recrystallization from cyclohexanone or methyl ethyl ketone removes traces of acidity (required, for example, for use with aluminum powder) and produces crystals of the desired size.

A process without acetic anhydride was also developed in Germany in 1940 (KH process). A modification is the addition of NH_4NO_3 to react with all CH_2 groups of hexamine (K process).

The KA process was developed during World War II in Germany, and the Bachman process was developed and is used in the United States. Both processes use acetic anhydride, and the reactions are very complex.

To a solution of hexamine (1 part) in glacial acetic acid (1.65 parts) are added a solution of NH_4NO_3 (1.5 parts) in concentrated HNO_3 (2 parts) and acetic anhydride (5.2 parts) at ca. 65 – 72 °C. The mixture is maintained at that temperature for at least 1 h, diluted with water, and heated to hydrolyze impurities. The yield is ca. 80 – 85 %; nitrous fumes are not evolved.

The product contains ca. 8 – 15 % HMX, depending on the reaction conditions. An

adequate source of acetic anhydride must be nearby, where acetic wastes can be dealt with. This process is easier to carry out than the process employing nitric acid alone, but its environmental problems are more difficult to solve. The same plant can be adapted to HMX production.

Both RDX and TNT are the basic components of almost all modern high explosives. They are mixed together, alone or with wax, or formulated with plastic binders. For a powerful and heat-stable explosive, RDX is preferred.

1,3,5,7-Tetranitro-1,3,5,7-tetraazacyclooctane [2691-41-0], $C_4H_8O_8N_8$, M_r 296.16 (**2**, $R = NO_2$), octahydrotetranitrotetrazocine, cyclotetramethylenetetranitramine, octogen, HMX, was discovered shortly before World War II as a byproduct of RDX synthesis by a Bachman-type process. It exists in four crystalline forms [4, 67, 68]. The β form has the highest density ($\rho = 1.907 \text{ g/cm}^3$) and a shock sensitivity similar to that of RDX. Large crystals of the α form are shock sensitive, but microcrystals are not.

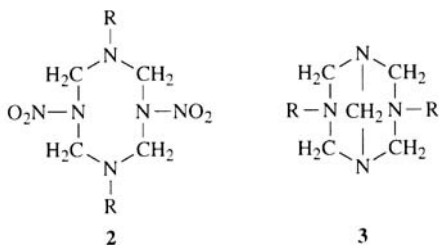

HMX is now obtained directly by a modified Bachman process. In this batch process, acetic anhydride and a mixture of NH_4NO_3 and HNO_3 are added simultaneously at $44 \pm 1 \text{ }^\circ\text{C}$ to hexamine dissolved in glacial acetic acid. After 15 min, the operation is repeated. The reaction mixture is aged at $45 - 60 \text{ }^\circ\text{C}$, diluted with hot water, and refluxed for up to several hours. The suspended HMX is filtered off and washed until neutral. The HMX is obtained as small crystals of the α form, which are transformed into the β form by recrystallization from acetone or DMSO.

HMX can also be obtained via dinitropentamethylenetetramine (DPT, **3**, $R = NO_2$) [69]. In another process starting from hexamine, the diacetyl intermediates DAPT (**3**, $R = COCH_3$) [70] and DADN (**2**, $R = COCH_3$) are isolated, and this is followed by nitration with nitric oleum. How-

ever, since demand for HMX is now very low, production by this route has ceased.

The price of HMX is usually 3 – 5 times that of RDX. It is used when high performance is required (e.g., shaped charges). Both RDX and HMX are also used in propellants.

Other High Explosives. Numerous nitramine derivatives have been studied. For example:

Dinitroglycoluril [55510-04-8] (DINGU or DNGU; **4**, $R = H$) has a high density (1.99 g/cm^3 , X-ray) [101] and explosive properties close to those of TATB [71, 72], but at a much lower price. It can replace part of the RDX in mixtures with TNT and can be introduced as a component in gunpowder. Some comparative thermodynamic properties are studied [73].

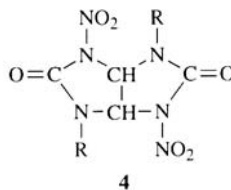

It is prepared by continuous nitration of glycoluril with 98 wt% HNO_3 at $30 - 60 \text{ }^\circ\text{C}$ in cascade-type reactors.

Tetranitroglycoluril (sorguyl; **4**, $R = NO_2$) prepared by nitration of DINGU with a mixture $HNO_3 - N_2O_5$, has a high density (2.01 g/cm^3), and detonation velocity (9300 m/s). Only one crystalline form is known. It must be coated or plastic bonded because it is sensitive to hydrolysis [71, 73, 75].

Hexanitrazaisowurtzitane (HNIW, CL-20). One way to obtain explosives of high crystal density is the synthesis of cage compounds such as HNIW, which was discovered in 1986 by A. NIELSEN [99].

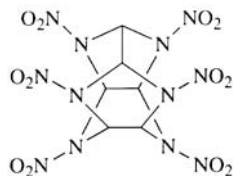

It is prepared by the reaction of benzylamine with glyoxal, followed by debenylation and nitration. It exists in six crystalline forms [93, 94]; the ϵ form has a density of 2.04 g/cm^3 . Production has begun in pilot plants [89]. It can be used as a high explosive and in propellant formulations.

Oxynitrotriazole [932-64-9], ONTA, NTO, 3-nitro-1,2,4-triazol-5-one, was first reported in 1905, but its use as a low-vulnerability explosive was only discovered in 1979 [97, 74]. It has a high density (1.91 g/cm^3), good detonation velocity, low sensitivity to impact and friction, and good thermal stability ($> 200 \text{ }^\circ\text{C}$) [98].

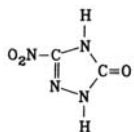

It is manufactured in two steps: reaction of the semicarbazide hydrochloride with formic acid to give the triazolone, which is nitrated with nitric acid. The NTO is recrystallized from water. NTO is used in LOVA formulations, some of which were tested in a joint LOVA programme of the USA, UK, Germany, and France.

Ammonium Dinitramide (ADN), $\text{NH}_4^+\text{N}(\text{NO}_2)_2^-$, $\rho 1.83 \text{ g/cm}^3$, $mp 92 \text{ }^\circ\text{C}$, is a carbon-free ammonium salt that was discovered and developed in the former Soviet Union in the 1960s and has in the mid-1990s been disclosed [100]. ADN is almost as hygroscopic as ammonium nitrate and very insensitive. It is of interest as a component of certain explosive mixtures and as a clean propellant.

6. High Explosive Mixtures

Explosives are used for global or directed destruction (bombs, torpedoes, mines, reactive armors, and warheads) or for pyrotechnics. Among pure compounds, only TNT and trinitrophenol are sufficiently insensitive to be loaded in large quantities by casting. Small quantities of other pure compounds are sometimes used for detonators or cutting or transmitting cords.

For flexible wrapped cords (detonating cords), the pure explosive (e.g., PETN) flows continu-

ously through a funnel to form a flowing stream that is wrapped in a thin plastic band. Thread is immediately woven on the plastic-enclosed explosive, and this is again encased with plastic by drawing through a die, which also helps adjust the loading density.

For metallic cords, the high explosive (PETN, RDX, HMX, or HNS) is introduced into a metallic tube (lead, copper, or silver), which is drawn through dies until the desired size and cross section are obtained.

Loading Processes. In casting processes, the explosive is employed as a solution or a liquid suspension; it is cast into the shell or in the mold, where it crystallizes on cooling (physical process) or solidifies by the cross-linking of a polymer (chemical process). In pressing processes, the explosive is introduced in granular form into a mold or shell and pressed with a piston at a pressure of 10 – 300 MPa; conditions depend on the munitions size, the binder, and the required mechanical properties. Special shapes are prepared by laminating or calendering.

Flexibility is increased by the use of blends, which can enhance explosive performances while preserving safety and reducing cost. Special effects, such as delayed detonation, are possible with improved safety and high-temperature stability.

6.2. Desensitized Explosives

Because of their sensitivity and high melting points, RDX, PETN, and HMX must be desensitized before casting or pressing. This is achieved by coating the particles with wax, sometimes with addition of graphite as a lubricating and antistatic agent. The beeswax used in the past has been replaced by paraffin or synthetic waxes, which give more reproducible results. The wax content in the explosive mixture is usually 2 – 10 wt %.

In the simplest process, the particles are coated in hot water. The explosive (RDX, for example) is vigorously stirred in water and heated slightly above the melting point of the wax, which is introduced and dispersed on the particles. The mixture is cooled by the rapid introduction of cold water, without formation of crusts on the vessel walls. The suspension is filtered and

dried. Coating agents melting above 100 °C are applied in a solvent (e.g., butyl acetate), which is removed by steam distillation. If the explosive is sensitive to hot water, the solvent is removed by filtration, possibly preceded by evaporation under vacuum. These processes are also used to prepare ternary mixtures of explosive aluminum and wax.

Detonation velocities can be obtained close to those of the pure explosives; e.g., for a mixture of 94.5 % RDX, 5 % wax, and 0.5 % graphite, $D = 8600$ m/s at $\rho = 1.76$ g/cm³ ($D = 8850$ m/s at $\rho = 1.82$ g/cm³ for pure RDX). However, large loadings are difficult to carry out because of problems with homogeneity, brittleness, porosity, and cost. The process is very useful for automatic filling of press-loaded small munitions.

6.3. TNT Mixtures

Molten TNT (mp 80 °C) is compatible with many explosives and other products, providing a castable melt above 80 °C. Among the products most frequently added are ammonium nitrate, to obtain very cheap munition loadings (amatols), and nitramines (RDX or HMX) or other high explosives (PETN, NTO), to improve performance. Mixtures containing 50 – 75 wt % RDX are used in bombs and warheads such as shaped charges. Some castable blends contain aluminum powder (tritonals, ammonals, Torpex, and HBX 1 and 3).

Wet and dry processes are employed. The former, the same as that used for desensitizing with low-melting wax, has cost and safety advantages. Almost the entire process is carried out under water. In France, RDX coated with 10 wt % TNT is produced in this manner, because its transportation as a dry product is allowed. However, air bubbles on the RDX crystals can create difficulties in loading.

In the dry process, the components are added dry to molten TNT with stirring, and the mixture is cast in shells. Wet RDX can be added to TNT at ca. 95 – 100 °C; the water is removed by decantation and evaporation.

Blends of TNT are used in the large-scale production of munitions. Shaped charges can be obtained by controlled sedimentation of the molten mixture. Crack formation in TNT during

cooling can be controlled by the addition of 1 % HNS.

Explosive performance is restricted by the condition that the mixture must be pourable; for example, for a blend of RDX:TNT of 70:30 (wt %), $D = 8060$ m/s at $\rho = 1.73$. (Since $\rho_{\text{theor}} = 1.765$, the porosity is ca. 2%.)

For blends with higher RDX or HMX content, a special apparatus such as a porous piston is used. Because of the danger of detonation by fire, mixtures of RDX with TNT are now forbidden on ships by some countries.

6.4. Plastic-Bonded Explosives (PBX)

Two different procedures are followed which improve the performance of new munitions.

Desensitized Explosives. Some new warheads require improved mechanical properties and stability at high temperature. Waxes are replaced by thermoplastics or by other plasticized polymers (nitrocellulose).

The manufacture of these plastic-bonded explosives resembles the use of waxes dissolved in a solvent immiscible with water. The molding powder is pressed, often in a heated and evacuated mold; for large charges, machining is necessary to obtain homogeneous charges of complex shapes with good mechanical properties at high temperature.

Examples include RDX or HMX boosters bonded with polyamide and mixtures of HMX and TATB containing 10 wt % fluorinated polymer [96]. Use is limited by the high cost of the pressing machines and the length of the processing cycle, especially for large charges.

Castable Explosives [76, 77]. For larger charges, mixtures are used of an explosive with a liquid binder, which is then cross-linked (composite explosives). A similar process is used for composite propellants. Composite explosives are being developed for uses requiring high accuracy and low vulnerability (LOVA explosives).

The liquid binder is introduced first into a mixer equipped with S-blades. A mixture of a diisocyanate and a diol (hydroxy-terminated polyether or polybutadiene) is usually employed in a precise ratio, with a precise quantity of a cross-linking agent such as a triol. The dry solid

explosive (RDX, HMX, or PETN) is then added and mixed under vacuum with additives (e.g., surfactants) and a catalyst providing a pot life, i. e., the mixture remains pourable, of a few hours. During this time the mixture is cast, sometimes under pressure or by injection, in vibrating and evacuated molds or shells. The molds are cured in an oven for a few days. Two different compositions may be cast, one over the other (bicompositions), to produce special detonation waves.

The main advantage of these formulations is their low sensitivity, especially against bullets, impact, and friction, and the difficulty of the transition from combustion to detonation. The mechanical properties can be excellent, and thermal stability is fair.

Among the drawbacks are the slow curing and high cost when a multimodal particle-size distribution is used to increase the explosive content. The detonation velocity is diminished by the inert character of the binder; it can be estimated by the Urizar formula [7, pp. 8 – 10], [78]. Energetic binders improve the detonation velocity, but increase sensitivity. A review of energetic binders is given in [15, 80]. The use of thermoplastic elastomers as binders is of interest for environmental reasons since they facilitate the dismantling of ammunition.

7. Industrial Explosives

For more than 350 years explosives have been employed to mine ores and minerals, as well as for quarrying, construction, dam building, tunneling, seismic exploration, metal forming and cladding, and demolition. The annual consumption of commercial explosives in Europe (EU 27 + Norway and Switzerland) in 2008 amounted to 550 000 t (which were initiated by 65×10^6 detonators). Each of the largest Western European countries used between 40 000 t and 60 000 t. World annual consumption of industrial explosives is at least 5×10^6 t, 75 % of which is ammonium nitrate–fuel oil (ANFO).

During the first 250 years of this period, only black powders were known and used, but fundamental changes occurred in the 1860s (invention of dynamite and blasting caps by NOBEL), 1950s (ANFO), 1980s (emulsion explosives) and 1990s with the introduction of mobile emulsion manufacturing units (MEMUs) for the on-site

mixing of explosives from non-explosive components and the commercialization of electronic initiation systems. The search continues for less expensive products and safer techniques for production and field use in mines, quarries, and road, tunnel, and dam construction. At the same time, the introduction of new products is restrained by the cost of existing investments and by safety, security, and environmental regulations.

7.1. Dynamites

Gelatine dynamites are powerful explosives whose main ingredients are nitroglycerin and/or nitroglycol, ammonium nitrate, and nitrocellulose. They were invented opportunely to replace black powder in the construction of railroad and tunnels and gave great impetus to the use of explosives. Although diminished in importance since the 1950s and progressively replaced by new types of explosive, dynamites are still widely used because of their excellent qualities and high performance. In 2007 dynamites accounted for 11 % of total European explosives consumption.

A detonation velocity range from 4300 to 7500 m/s provides high brisance. Sensitivity to initiation by cap or detonating cord is very good, as is the flashover coefficient. Density (ca. 1.4 g/cm^3), water resistance, and detonation pressure are high.

The composition of dynamites has changed only slightly since their origin. Nitroglycerin, gelatinized by nitrocellulose, has been totally or partially replaced by nitroglycol to reduce costs and permit lower operating temperatures. However, nitroglycol is more toxic than nitroglycerin, and its use is limited in some countries. Oxidizers such as ammonium nitrate reduce the cost of low-energy formulas. Combustible components (wood meal, peat, silicon, and aluminum) and other additives (sodium nitrate, ammonium chloride, and sodium chloride), provide formulations with specialized properties.

The consistency of such mixtures varies according to the nitroglycerin – nitroglycol content. Gelatin dynamites containing 20 – 40 wt % of nitroglycerin – nitroglycol form a plastic paste that may be made into paper-wrapped (Rollex process, small calibers up to 50 mm) or plastic film (large caliber, over 50 mm)

cartridges after cutting or extrusion. Dynamites containing 10 – 20 wt % nitroglycerin – nitroglycol are powdery, and tampers are required to make cartridges. They have been largely replaced by the new explosives, except for use in coal mines, where the potential presence of dangerous dust and gas means that only very safe explosives with the lowest possible detonation temperature should be used. Permissible explosives for these applications usually contain a large amount of ammonium nitrate and sodium chloride as cooling salts, the endothermic melting of which absorbs much of the energy released by the detonation. Historically, there are no harmonized standards for permitted explosives in Europe. Degrees of safety in coal mines are defined by national regulations. In Germany there are three safety classes. Class three is the safest group with reduced detonation temperature and energy and which is safe against coal dust and methane mixtures. In France the classes are *rocher*, *couche*, and *couche améliorée*. The first refers to less safe explosives, permitted for underground use only. In Great Britain, an explosive is approved by the Minister of Power and placed on the Permitted List after it has passed the official gallery tests prescribed for the particular class of explosives to which it belongs. These tests are carried out at the Safety in Mines Research Establishment Testing Station at Buxton. The safety classes are P1 to P5 with P5 or P4/P5 being the safest class which is used in coal mines to reduce the hazard of firedamp or coal-dust ignitions which might occur in gassy or dusty mines.

Dynamites are marketed in cylindrical paper, cardboard, or plastic cartridges. The characteristics of a standard composition are given in Table 4.

7.2. Ammonium Nitrate Explosives (Ammonites)

Ammonium nitrate (AN) explosives were developed in European countries to replace explosives made with chlorates. They appeared later in the United States (Nitramon, DuPont, in 1935).

AN explosives are made with ammonium nitrate (ca. 80 wt %) sensitized with a nitro compound (TNT, PETN, or their mixtures, called Pentolite). Formulas can include aluminum powder and other additives. These products are characterized by their good production safety and low production cost. They show good sensitivity when initiated by detonators and detonating cords. However, they are sensitive to humidity. Properties of a typical Ammonite are as follows:

Composition, wt %	
Ammonium nitrate	81.5
High explosive	16
Aluminum	0
Mass energy, kJ/g	3.51
Detonation velocity, m/s	4800
Flashover coefficient, cm	2
Detonating pressure	6.34
Density, g/cm ³	1.10

Ammonium nitrate explosives made in the United States may contain dinitrotoluene (DNT) but no nitro high explosive. They are produced by blending and as a result are not cap sensitive. The U.S. Government, followed by other governments, has established a category with relaxed rules for the transport and storage of these explosives. This category was first called NCN (nitrocarbonitrate) and is now known as blasting agents. They have been progressively replaced by water gels and emulsion explosives.

Table 4. Properties of dynamites

Property	F16	F19	GDC 16
Nitroglycerin/nitroglycol, wt %	32	40	12
Classification	gelatin	gelatin	powder
Application	general and underground	general and underground	permissible
Mass energy, kJ/g	3.97	4.15	1.78
Detonation velocity, m/s	6000	6500	2200
Flashover coefficient*, cm	8	10	10
Cartridging density, g/cm ³	1.45	1.45	1.10
Detonation pressure**	13.05	15.32	13.31

* Maximum distance at which a cartridge of diameter 30 mm and weight 50 g has a 50 % probability of initiating another cartridge.

** Calculated with the formula $\frac{1}{4}AD^2$.

7.3. Ammonium Nitrate/Fuel Oil Explosives (ANFO/ANC Explosives)

Ammonium nitrate/fuel oil (ANFO/ANC) explosives have been developed since 1955. They are manufactured from porous prills of ammonium nitrate (ca. 94 wt %) soaked in mineral oil, usually domestic fuel oil (ca. 6 wt %) or native oils like rapeseed oil methyl ester. In some cases, aluminum powder is added to increase the explosive strength. ANFO accounted for 41 % of total European explosives consumption in 2007.

Ammonium nitrate/fuel oil explosives are usually delivered in packaged or bulk form. They can be made on-site in a mobile mixing unit, often mounted on a truck (ANFO truck). Relative to their lower inherent energy they are inexpensive and safe to handle, but lower in strength, performance, detonation velocity, and detonating pressure in comparison to dynamites or emulsion explosives. In addition, they cannot be used in the presence of water. Because of their very low sensitivity, they require powerful primer charges, powerful detonating cords, dynamite relay cartridges, and boosters. The densities are low. Properties are listed in Table 5.

7.4. Slurries and Water Gels

A new class of industrial explosives, known as water explosives has been developed since 1956; they contain no nitroglycerin and are based on a solution of nitrates, thus containing considerable water (10 – 15 wt %). During the 1970s and 1980s, water explosives have taken over much of the market, at the expense of dynamites and AN powders, because of their lower production and raw material costs and improved safety during production and handling.

Table 5. Properties of ANFO explosives for general applications

Property	N 135	D7 fuel
Composition, wt %		
Ammonium nitrate	91	94.3
Fuel oil	4	5.7
Aluminum	5	0.0
Mass energy, kJ/g	3.43	2.74
Detonation velocity, m/s	3900	3700
Detonating pressure	3.42	2.84
Density, g/cm ³	0.9	0.83

Table 6. Properties of water gel and slurry explosives for general applications

Property	Hydrolite AP, in bulk	Gelsurite 3000, in cartridges
Composition, wt %		
Nitrates	46	61.6
Water	15	13
Aluminum	0	15
High explosive	27	0
Mass energy, kJ/g	2.70	3.87
Detonation velocity, m/s	5100	4000
Flashover coefficient, cm	0	5
Detonating pressure	9.75	4.80
Density, g/cm ³	1.50	1.20

Water gel explosives are supplied in cartridges or in bulk form. The bulk explosives are poured or pumped into the blast holes. Cartridges are formed with a continuous through-circulation device (CHUBPACK) in cylindrical plastic cartridges closed by metal clips.

Slurries and water gels are made of aqueous solutions of ammonium nitrate and sodium or calcium nitrate gelled by the addition of guar gum or cross-linking agents. They are sensitized by nitro explosives, organic amine nitrates, or by aluminum powder. Combustible materials, such as aluminum, urea, sugar, or glycol, are mixed with these solutions either continuously or discontinuously.

The presence of reactive aluminum, water, and ammonium nitrate requires careful control to avoid chemical side reactions. The typical properties of water gel explosives and slurries are listed in Table 6.

7.5. Emulsion Explosives

Since the cost of sensitizer for slurry explosives is high, other formulas based on nitrate solutions containing cheaper raw materials have been investigated. This led in 1962 to the development of “water-in-oil” and “oil-in-water” emulsion explosives, whose sensitivity is due to the presence of air bubbles; these are most efficiently introduced by means of hollow glass bubbles (microspheres) or chemical gassing techniques.

Emulsion explosives are produced, similar to water gels, by a continuous or a batch process. They can be supplied in cartridges of various diameters (25 to 120 mm), lengths, and weights,

Table 7. Properties of explosive emulsions used for general and underground applications

Property	Iremite 1000 in cartridges	Iremite 4000 in cartridges	Iremite 2500s in cartridges	Gemulsite 100 for pumping
Mass energy, kJ/g	3.34	3.92	3.51	3.49
Detonation velocity m/s	5300	5300	5500	5100
Flashover coefficient, cm	> 5	> 5	5	
Detonating pressure	8.43	8.43	9.08	7.80
Density, g/cm ³	1.20	1.20	1.20	1.20

or in bulk form. Bulk emulsion explosives are manufactured from nonexplosive components (emulsion matrix plus gassing agents and/or glass microspheres plus optionally ammonium nitrate prills or ANFO) on the quarry bench by mobile manufacturing units (MMU) and are pumped directly into blast holes on demand. Once inside the blast hole they start the sensitizing reaction due to the specific weight decreasing from about 1.4 to 1.1 g/cm³ due to the development of gas bubbles (chemical gassing process). Although the emulsions are neither gelled nor reticulated, their storage life has been considerably improved by using sophisticated emulsifiers.

Emulsions differ from nitrate/fuel oil, nitrate, and water gels in their higher detonation velocity. The properties of typical emulsion-type products are listed in Table 7. The emulsions are sensitized by a chemical gassing process, apart from Iremite 2500s, the formulation of which includes microspherical glass bubbles. Since the emulsion bulk explosives are usually sensitized just before filling the components into the blast holes the unsensitized substances are not classified as an explosive (class 1) and are not entirely subject to the regulations for producing, handling, transporting, and storing dangerous materials.

About 70 % of the EMS consumed in Europe comes in bulk form. In 2007 emulsion explosives accounted for 48 % of the total European explosives consumption.

7.6. Uses

The energy provided by explosives is used in a number of ways, including explosive cladding (see Section 3.3), metal working (forming, welding, and cutting), and shearing by pyrotechnics systems. However, the principal nonmilitary use of explosives is in mining, quarrying, tunneling, dam building, demolition, and construction.

These applications are governed by extensive safety and security regulations and is subject to competition from increasingly powerful mechanical means of extraction, such as mining machines, rippers, and tunnel-boring machines. Although the use of explosives entails such drawbacks as noise, vibration, dust, and smoke, the technique is flexible, effective, easy to use, and low in capital and material cost.

When using bulk explosives, production costs are reduced because the process of loading into cartridges and the labor-intensive filling of the blast holes become unnecessary. In addition, since the entire blast hole is completely filled, the filling grade is much better compared to cartridge explosives, allowing the possibility of enlarging the drilling pipe. The bulk explosives (ANFO and EMS) make up 70 % of those used in Europe, and over 80 % of those used in the United States. They can be produced on-site in mobile emulsion manufacturing units (MEMUs, ANFO trucks, pump trucks).

The introduction of improved blasting systems nowadays allows for a relatively exact forecast of the blasting results by evaluating all relevant blasting parameters, such as bench and wall dimensions, type of rock, required fragmentation, avoidance of fines, reduction of noise and vibrations, and the avoidance of fly rock. These systems use specific software, computerized lasers, vibration-measuring equipment, electronic devices for measuring the inclination of the bore holes, and computer programs to calculate the ideal placement of the drill holes and the correct combination of delay times of the detonators for the initiation of the explosive charges. Electronic detonators can be incorporated into such systems by selecting the optimal delay time by the millisecond, whereas conventional initiation systems such as electric or nonelectric detonators have fixed delay intervals such as 25 ms (short period) or 250/500 ms (long period).

8. Test Methods

Tests of secondary explosives are designed to study detonation phenomena, to approve a product, and to verify that manufactured lots meet the requirements (i.e., quality control).

Detonation phenomena (10^{-9} to 10^{-12} s) are observed by laser interferometry, streak cameras, and X-ray flashes, all electromagnetic methods. The very high instantaneous pressures (10 – 40 MPa) are measured, e.g., with low-impedance piezoresistive manganin gauges (Cu–Mn–Ni alloy) [79] or with fluorinated piezo polymers as shock sensors [102]. Phenomena are modeled on the basis of the Becker – Kistiakowsky – Wilson (BKW) [32] or Jones – Wilkins – Lee (JWL) [33] equations developed in the United States at the Los Alamos Scientific Laboratories (LASL) and the Lawrence Livermore National Laboratory (LLNL).

Tests to approve a product measure detonation velocity and pressure, energy released, ability to initiate or transmit detonation, and critical diameter. They also determine the safety characteristics in use, storage, and transportation.

The verification of a lot is usually based on the determination of physical properties (melting point, particle size, specific area) and chemical analysis. Safety and storage characteristics must match those of the approved product.

Codified tests for military use are published in the United States as military specifications (MIL), in France as *Manuel des modes opératoires*, in the Federal Republic of Germany as VTL, in the United Kingdom as DEF. STAN, and at NATO as STANAG. Japan issues *Japanese Industrial Standards* [81]. Unified and standardized European explosives tests (EXTEST) are published in *Explosifs* (Belgium, 1960 – 1970), in *Explosivstoffe* (FRG, 1971 – 1973), in *Propellants and Explosives* (FRG, 1977 to 1981), and in *Propellants, Explosives, Pyrotechnics* (1982 to date) (see also [7, 10]).

8.1. Performance Tests

Detonation Velocity. The *Dautriche method* is based on a comparison of the velocity in two parts of a circuit, composed in one section of a known detonating cord and in the other of a

cartridge made with the test sample. The detonation wave fronts run in opposite directions in the two segments and collide at a precise point [82].

More sophisticated electrical or optical methods are also available. For example, electrical wires (switches), inserted into a cylindrical cartridge at precise locations, are short-circuited by the passage of the detonation wave, giving a signal that is recorded on a chronograph. Other methods use streak cameras. The detonation wave is built up at a distance from the initiation point, and this occurs only if the cartridge diameter is large enough. Therefore, this test requires an adequate quantity of explosive.

Energy Output [5, 82]. In the *lead block test*, strength or CUP (*coefficient d'utilisation pratique*) is measured by the expansion of a cavity in a lead block caused by the detonation of a sample of explosive, in comparison with a standard (PETN, picric acid, or TNT).

In the *ballistic mortar test*, the energy released by detonation gases is measured in a steel mortar consisting of two cavities: the first contains the explosive, and is connected to the second, which contains a projectile. The assembly is suspended by a pendulum, and when the projectile is driven out by the detonation, the recoil moves the mortar to an angle that is compared to that given by a standard explosive.

The *Kast method* is used to evaluate explosive brisance, a value related to the product ρD^2 where ρ = density and D = detonation velocity. The crushing of a copper cylinder by the detonation is compared to that obtained with a standard explosive.

The *cylinder test* has been studied at the Lawrence National Laboratory, Livermore, California, [83]. The velocity transmitted by a cylindrical rod of explosive to a tightly fitting copper tube is measured by a streak camera.

For more routine measurements, the *Défourneaux test* can be used (push-plate test). A metal plate lies on an explosive plate, which is detonated by a linear wave generator. During the detonation, the metal plate is continuously bent to an angle, which is observed, for example, by X-ray flash [84]. Among other tests is underwater explosion, with measurements of the bubble produced.

Other Performance Tests. In one of the critical-diameter tests, the detonation propagation of metal cords (copper or silver) filled with an explosive of known density is observed as a function of the inner diameter. In another method, a conical charge is used.

Other tests include the determination of the coefficient of transmission of detonation, the sensitivity to initiation, the self-excitation coefficient (maximum distance between two cartridges loaded with the same explosive, allowing the initiation of one by the other), and the plate-dent test.

8.2. Safety

Stability. Aging effects are frequently determined by the *vacuum stability test*, in addition to the usual chemical methods. It can be used to study the compatibility between explosives and other materials.

The sample is placed in a test tube fitted with a manometric capillary glass tube; the other end of the tube dips into a cup of mercury. The tube is evacuated and the sample is heated, usually between 80 and 130 °C. The variation of the inner pressure in the tube is shown by the mercury level. Pressure usually increases during the first few hours with the release of traces of moisture and volatile substances. Afterward, during a period of 100 h, the rise in pressure can be linear (constant decomposition rate) or more rapid (autocatalytic decomposition).

Sensitivity. The *impact sensitivity* of an explosive is the minimum energy that causes quick decomposition [5, 13, 85]. The test conditions strongly influence the results, which (given in Joules) are only orders of magnitude. The classification of explosives depends on the apparatus and the test conditions.

In the Bruceton test for impact sensitivity, the stimulus after a positive result is lowered by one unit and raised after a negative result. The value of the sensitivity is obtained as the mean of 30 – 50 trials. Probabilistic values are also determined.

The procedures differ in the size and placement of the sample and the use of tools exposed or covered with sandpaper. The reaction may be

followed visually, aurally, audiometrically, or by examination of gas evolution.

Tests are prescribed by the U.S. Bureau of Mines, Picatinny Arsenal (United States), Explosives Research Laboratory (United States), BAM (Federal Republic of Germany), Julius Peters (Federal Republic of Germany, France), Rotter (United Kingdom, Canada), and Aubertein (France). Another test is the Susan projectile-impact test, where a projectile containing ca. 450 g of explosive is directed against a hard target at selected velocities.

The *friction sensitivity test* is even more difficult to reproduce than the impact sensitivity test. A thin layer of sieved explosive on a fixed surface is rubbed by a hard or abrasive surface moved by translation (Julius Peters apparatus) or by rotation (U.S. Bureau of Mines) under adjustable pressure.

Impact and friction are combined in the skid test (Pantex) and the Popolato test; an explosive sphere is projected against a sand-coated target plate at defined impact angles.

In the *electrostatic sensitivity test*, a small quantity of explosive is placed between two electrodes. A capacitor discharge causes a spark to pass between the electrodes through the explosive. The sensitivity is expressed by the minimum energy required to decompose the sample.

In addition to differential thermal analysis (DTA) and thermogravimetric analysis (TGA), the following *heat sensitivity tests* are employed:

1. The sample is subjected to a constant increase of temperature and the decomposition or ignition temperature is noted; the result depends on the quantity of explosive and the rate of heating.
2. The sample placed in a small bulb is dipped into a Wood's metal bath maintained at a fixed temperature. The time to decomposition is noted, or the temperature at which a decomposition occurs after 5 s.
3. The sample is ignited in a gutter and the burning rate measured.
4. The sample is externally heated in a closed or half-closed vessel. The tendency to burn or to detonate is observed (steel-sleeve test).
5. The sample is heated at a given rate in a closed vessel. The time of detonation or the temperature at which the sample detonates after a given time is noted (cook-off test).

To test the *sensitivity to initiation* through a spacer (card-gap test), a sample in a steel tube is subjected to the detonation of a standard booster explosive separated from the sample by a barrier of cellulose acetate cards of 0.19 mm thickness [8]. The minimum number of cards that prevent transmission of detonation fixes the legal class of the explosive for transportation and other regulations.

To obtain a LOVA agreement (MURAT in France), the following tests must be carried out on ammunitions: bullet and fragment impact, slow and fast cook-off tests, reaction towards a shaped-charge jet, and sympathetic reactions. The results depend on storage of the ammunitions, their design, and on the properties of the propellants and explosives they contain [95, 20]. These investigations are supported by the NATO Insensitive Munitions Information Center (NIMIC, Brussels).

9. Legal Aspects and Production

European Directives and national legislation strictly regulate the possession, production, storage, packaging, shipping, handling, use, export, import, transfer, and trading of explosives. Periodic inspections and labeling prevent theft. Tagging the explosive permits tracing its origin. In cases where unauthorized explosives are found, there is an absolute necessity to identify the last official owner of these explosives as quickly as possible. For this reason an EC Directive on the identification and traceability of explosives for civil use was passed in 2008. Under the Directive all explosives articles would be marked with a unique identification both in human-readable and in bar-code or matrix-code format. Implementation of the scheme should be taken forward by the EC member states in 2012 at the latest. The ADR regulations regulate the transport, packaging, and labeling of hazardous goods such as explosives on the road. Other organizations like the IMO and ICAO regulate transport by sea and air accordingly.

9.1. Safety Regulations

Originally, each country established its own regulations; the standardization recommended

by the UN was first published in 1984 in the so-called Orange Book (Recommendations on the Transport of Dangerous Goods – Model Regulations and Manual of Tests and Criteria) [86]. Substances are classified according to the type of risk involved, unless they are too dangerous to ship. Explosives are in Class 1, which contains six subdivisions [86]:

- Division 1.1: Substances and articles which have a mass explosion hazard
- Division 1.2: Substances and articles which have a projection hazard but not a mass explosion hazard
- Division 1.3: Substances and articles which have a fire hazard and either a minor blast hazard or a minor projection hazard or both, but not a mass explosion hazard
- Division 1.4: Substances and articles which present no significant hazard
- Division 1.5: Very insensitive substances which have a mass explosion hazard
- Division 1.6: Extremely insensitive articles which do not have a mass explosion hazard

Class 1 is restricted, containing only registered substances; for new substances, test results must be presented. Simultaneous transport and storage are permitted for “compatibility groups”.

The transportation regulations specify packaging and labeling instructions, an identifying insignia on vehicles, compatibilities, and maximum load and safety devices on vehicles.

Manufacture and storage are governed by the TNT equivalency, which is defined as the quantity of TNT producing the same effects as 100 kg of the explosive [87].

The expression $d = k Q^{1/3}$ gives the safe distance from a load Q of explosive (expressed as TNT equivalent), where the constant k depends on the presence of walls or other protection.

9.2. Production of Military Explosives

High explosives are manufactured by private companies in many countries, e.g., Russia, United States, China, India, United Kingdom, Germany, Norway, Sweden, Switzerland, and Japan.

In the United States, research and development involving high explosives are often undertaken in military laboratories. Production is conducted by arsenals or by private companies under the GOCO system (Government owned – contractor operated), in which investments and factories are owned by the government. The product is government property and cannot be sold by the operating company.

Since 1990 the production and consumption volumes in the EU of explosives for defense purposes have reduced to a few thousand tonnes annually.

10. Toxicology and Occupational Health

Raw Materials. Both acids (HNO_3 and H_2SO_4) and benzene derivatives (toluene and chlorobenzene) are of concern [4]. The usual safety measures must be followed to protect eyes, skin, and respiratory tract. Red fumes of nitrogen oxides, formed normally or by accident, can induce lung edema two days after exposure; the use of a gas mask is recommended.

Explosives. Some *primary explosives* are toxic (mercury fulminate and certain lead salts), but the toxic hazards are far below those arising from high sensitivities to detonation. Among the secondary explosives, *nitroglycerin* and other liquid nitrates exhibit hypotensive action accompanied by headaches and, in chronic cases, by methemoglobinemia. A tolerance to nitroglycerin can be developed. These substances are usually absorbed through the skin rather than by inhalation. For nitroglycerin and glycol dinitrate, $\text{TLV} = 1.5 \text{ mg/m}^3$. *PETN*, which like nitroglycerin is prescribed for heart diseases, has a very low vapor pressure and is not readily absorbed by the skin.

The toxic effects of *TNT* include blood changes, cyanosis, methemoglobinemia, and toxic hepatitis. It is introduced by inhalation, ingestion, and skin absorption; at inhalation level, $\text{TLV} = \text{ca. } 1 \text{ mg/m}^3$. Dust in the plant is to be avoided.

Tetryl can induce an allergic dermatitis, therefore its use is practically abandoned.

Both *RDX* and *HMX* have negligible vapor pressures. They do not penetrate the skin and

their toxicity is very low. However, there have been reports of epileptiform convulsions, without liver involvement, or carcinogenic or mutagenic effects. Dust formation should be avoided and masks should be worn.

References

General References

- 1 *Ullmann's Encyclopädie der Technischen Chemie*, 4th ed., **21**, 637 – 697, Verlag Chemie, Weinheim 1972–1984.
- 2 T. Urbanski: *Chemistry and Technology of Explosives*, Pergamon Press, Oxford 1983 – 1985.
- 3 A. Marshall: *Explosives*, 2nd ed., P. Blakiston's Son and Co., Philadelphia 1917.
- 4 B. T. Fedoroff *et al.*: *Encyclopedia of Explosives and Related Items*, U.S. Army and National Technical Information Service, Springfield, Va., 1960 – 1983.
- 5 R. Meyer: *Explosives*, 2nd ed., Verlag Chemie, Weinheim-New York 1981.
- 6 *Kirk-Othmer*, **9**, 561 – 620, and **15**, 841 – 853.
- 7 B. M. Dobratz: *LLNL Explosives Handbook*, UCRL Report 52 997, Livermore, Calif., 1981. B. M. Dobratz: *LLNL Explosives Handbook*, UCRL Report 52 997, Change 2, Livermore, CA 1985.
- 8 J. Quinchon *et al.*: *Les explosifs*, 2nd ed., Technique et Documentation, Paris 1987.
- 9 J. Quinchon, R. Amiable, P. Chereau: *Sécurité et hygiène du travail dans l'industrie des substances explosives*, 2nd ed., Technique et Documentation, Paris 1985.
- 10 L. Médard: *Les explosifs occasionnels*, *Technique et Documentation Paris 1979*, (engl. Transl.: *Accidental Explosives*), Ellis Horward Ltd (Distrib. J. Wiley & Sons) 1987.
- 11 J. Calzia: *Les substances explosives et leurs nuisances*, Dunod, Paris 1969.
- 12 S. Fordham: *High Explosives and Propellants*, 2nd ed., Pergamon Press, Oxford 1980.
- 13 H. D. Fair, R. F. Walker: *Energetic Materials. Inorganic Azides*, Plenum Press, New York 1977.
- 14 *Houben-Weyl*, **XI and XII**, 99 – 116.
- 15 *Structure and Properties of Energetic Materials*, *Symp. Proceedings*, vol. 296, Materials Research Society 1992. *Composition, Combustion and Detonation Chemistry of Energetic Materials*, *Symp. Proceedings*, vol. 418, Materials Research Society, Pittsburgh, USA, 1995.
- 16 J. E. Field, P. Gray, *Energetic Materials*, The Royal Society, London 1992.
- 17 Approches microscopique et macroscopique des detonations, *Journ. de Physique*, Suppl., 1^{er} atelier int. (31. May — 07. June 1987). Approches microscopique et macroscopique des detonations, *Journ. de Physique*, Suppl., 2^e atelier int. (02. — 07. October 1994).
- 18 Proc. Int. Symp. Energetic Materials, Paris, May 1994; *International Défense et Technologie*, Sept. 1994.

- 19 *Europyro*, 5^e *Congres Int. de Pyrotechnie*, 1993. *Euro-pyro*, 6^e *Congres Int. de Pyrotechnie*, 1995. *Europyro*, 7^e *Congres Int. de Pyrotechnie*, 1999.
- 20 *Insensitive Munitions Technology Symposium*, ADPA (American Defense Preparedness Association) 1996.
- 21 *Life Cycle of Energetic Materials, Conferences Proceedings (1993, 1994, 1996)*, Los Alamos Lab.
- 22 G. A. Olah *et al.*, *Nitration. Methods and Mechanisms*, VCH Publishers 1989. Useful periodicals treating explosives include *ICT Intern. Jahrestg.* (1970 to date); *Propellants and Explosives* (1976 – 1981), continued as *Propellants, Explosives, Pyrotechnics* (1982 to date); *Symposia on Detonation (United States)*; and *Explosion and Explosives* (translation of Kogyo Kayaku (published by the Industrial Explosives Society of Japan) that is published by the NSF, Washington).
- ### Specific References
- 23 D. L. Chapman, *Phil. Mag.* **47** (1899) 90.
- 24 E. Jouguet, *J. Math. Pures. Appl. Paris* **60** (1905) 347.
- 25 I. B. Zeldovich, *NACA Techn. Memo.* no. 1261 (1950).
- 26 V. von Neumann, OSRD Report 549 (1942).
- 27 W. Döring, G. Burkhardt, *Air Material Command Technical Report F-TS-1227-IA* (GDAM A9 – T46) (1949).
- 28 F. Bauer, MRS Fall Meeting Boston 2001. Session “Electroactive Polymers”.
- 29 *Détonique Théorique*, Edition de l’Ecole Nationale Sup. des Techniques Avancées, Paris 1981.
- 30 J. O. Hirschfelder *et al.*: *Molecular Theory of Gases and Liquids*, J. Wiley & Sons, New York 1954.
- 31 M. Cowperthwaite, W. H. Zwisler, *Symposium (International) on Detonation*, 6th, Office of Naval Research Report ACR-221 (1976).
- 32 C. L. Mader, Los Alamos Laboratory Report CA-2900 (1963).
- 33 E. L. Lee, H. C. Hornig, J. W. Kury, UCRL Report 50 422.
- 34 M. J. Kamlet, S. J. Jacobs, *J. Chem. Phys.* **48** (1968) 23.
- 35 L. R. Rothstein, *Propellants Explos.* **4** (1979) 56 – 60; *Propellants Explos.* **6** (1981) 91.
- 36 C. H. Johansson, P. A. Persson: *Detonics of High Explosives*, Academic Press, London-New York 1970.
- 37 A. F. Belyaev: *Combustion, Detonation and Explosive Work of Condensed System*, USSR Academy of Science, Moscow 1968.
- 38 A. K. Parfenov, A. Y. Apin, *ATD Press* **4** (1965) no. 113.
- 39 R. R. Bernecker *et al.*, *Symposium (International) on Detonation*, 7th, Office of Naval Research Report NSWC MP 82 – 334 (1981).
- 40 M. Samirant, *Symposium (International) on Detonation*, 7th, Office of Naval Research Report NSWC MP 82 – 334 (1981).
- 41 C. Fauquignon, H. Moulard, *Sciences et Techniques de l’Armement* **1** (1984) 27.
- 42 F. P. Bowden, A. D. Yoffe: *Initiation and Growth of Explosives in Liquids and Solids*, Cambridge University Press, 1952.
- 43 C. M. Tarver, J. O. Hallquist, *Symposium (International) on Detonation*, 7th, Office of Naval Research Report NSWC MP 82 – 334 (1981).
- 44 F. E. Walker, R. J. Wasley, *Explosivstoffe* **17** (1969) 9.
- 45 Y. de Longueville, C. Fauquignon, H. Moulard, *Symposium (International) on Detonation*, 6th, Office of Naval Research Report ACR-221 (1976).
- 46 D. Price, *Symp. (Int.) Combust. 11th* (1967) 963.
- 47 S. J. Jacobs, Naval Ordnance Laboratory Technical Report 74 – 86.
- 48 M. L. Wilkins, UCRL Report 90 142 (1983).
- 49 V. D. Linse, H. E. Otto, P. Pocaliko: “Explosion Welding”, *Welding Handbook*, vol. 3, Am. Welding Soc., Miami 1980.
- 50 M. Défourneaux, *Sciences et Techniques de l’Armement*, Paris 2 (1970) 293.
- 51 J. Dubar, J. Calzia, *C.R. Seances Acad. Sci. Sér. C* **266** (1968) 1114 – 1116.
- 52 T. Urbanski: *Chemistry and Technology of Explosives*, vol. 1, Pergamon Press, Oxford 1983, pp. 139 – 151.
- 53 P. Aubertein, *Mém. Poudres* **30** (1948) 7 – 42.
- 54 M. J. Barbieri, *Mém. Poudres* **26** (1935) 294 – 302.
- 55 E. E. Gilbert *et al.*, *Propellants Explos. Pyrotech.* **7** (1982) 150 – 154.
- 56 J. P. Konrat, FR 1 258 323, 1961; *Chem. Abstr.* **57** (1962) P 3358 h.
- 57 M. L. Kastens, J. F. Koplán, *Ind. Eng. Chem.* **42** (1950) 402 – 413.
- 58 K. G. Shipp, *J. Org. Chem.* **29** (1964) 2620 – 2623.
- 59 SNPE, FR 2 256 144, 1973 (J. M. Emeury, L. Leroux).
- 60 E. E. Gilbert, *Propellants Explos.* **5** (1980) 168 – 172.
- 61 S. E. Klassen [Sandia ABQ] 32th Int. Ann. Conf. ICT (2001) 24 (1 – 12).
- 62 T. M. Benziger, *ICT Intern. Jahrestg.* 1981, 491 – 503.
- 63 U. S. Energy R. and D. Adm., US 4 032 377, 1977 (T. M. Benziger).
- 64 DE 104 280, 1898 (G. F. Henning).
- 65 G. Desseigne, *Mém. Poudres* **28** (1938) 156 – 170.
- 66 J. Issoire, G. Burlet, *Mém. Poudres* **39** (1957) 65 – 95; **40** (1958) 47 – 76.
- 67 H. H. Cady, A. C. Larson, D. T. Cromer, *Acta Crystallogr.* **16** (1963) 617 – 623.
- 68 H. H. Cady, *ICT Intern. Jahrestg.* 1986, 17, 1 – 12.
- 69 J. A. Bell, I. Dunstan, *J. Chem. Soc. C* 1969, 1556 – 1562.
- 70 V. I. Siele *et al.*, *Propellants Explos.* **6** (1981) 67 – 73.
- 71 J. P. Kehren, *ICT Intern. Jahrestg.* 1976, 47 – 58. J. Boileau, J. M. Emeury, Y. de Longueville, P. Monteagudo, *ICT Intern. Jahrestg.* 1981, 505 – 526.
- 72 M. Stinecipher, L.A. Sketg, 8th Int. Symposium on Detonation (1985) 351 – 360.
- 73 V. P. Sinditskii, V. Y. Egorshv, M. V. Berezin, 32th Int. Ann. Conf. ICT (2001) 59 (1 – 13).
- 74 M. D. Coburn, B. W. Harris, K. Y. Lee, M. M. Stinecipher, H. H. Hayden, *Ind. Eng. Chem. Prod. Res. Dev.* **25** (1986) 68 – 72.
- 75 E. Wimmer: “Dérivés nitrés du glycoluril”, Thèse, Université d’Aix-Marseille, 1985.

- 76 G. Roche, *ICT Intern. Jahrestg.* 1978, 235 – 242.
- 77 L. R. Rothstein, *ICT Intern. Jahrestg.* 1982, 245 – 256.
- 78 C. Gaudin, *ICT Intern. Jahrestg.* 1978, 243 – 254; 1981, 541 – 551.
- 79 M. J. Ginsberg, A. R. Anderson, J. Wackerle, *Symposium sur les jauges et matériaux piezoresistifs, 1st*, Arcachon, France, 1981. L. M. Erickson *et al.*, *ibid.*
- 80 J. Boileau, *MRS Symposium Proceedings* 418 (1996) 91 – 102.
- 81 I. Fukiyama, *Propellants Explos.* **5** (1980) 94 – 95.
- 82 H. Ahrens, *Propellants Explos.* **2** (1977) 7 – 20.
- 83 J. W. Kury *et al.*, *Symposium on Detonation, 4th* (1965) 3.
- 84 M. Défourneaux, *Sciences et Techniques de l'Armement* **47** (1973) 723 – 814, 847 – 930.
- 85 K. N. Bascombe, R. M. H. Wyatt, *ICT Intern. Jahrestg.* 1976, 211 – 231.
- 86 United Nations Organization: *Transport of Dangerous Goods*, 14th ed., 2005.
- 87 D. M. Koger, *ICT Intern. Jahrestg.* 1980, 549 – 560.
- 88 J. Ding, *The discovery of gunpowder and shockwaves in China — CETR rep. A 12–89*, New Mexico Tech., Socorro, 1989.
- 89 A. B. Sheremetev, T. S. Pivina, *ICT Int. Jahrestg.* 1996, 30, 1 – 11.
- 90 FR 1060425, 1952 (C. Frejacques). J. P. Passarello, Thesis (ENSTA-Paris), 1996.
- 91 R. W. Millar *et al.*, *ICT Int. Jahrestg.* 1996, 26, 1 – 14.
- 92 R. B. Wardle, *et al.*, *ICT Int. Jahrestg.* 1996, 27, 1 – 10.
- 93 M. F. Foltz, *Prop. Exp. Pyro.* **19**, 1994 63–69 and 133–144.
- 94 N. V. Chugehov, F. Volk, *ICT Intern. Jahrestg.* 2001, 101, 1–9.
- 95 A. Sanderoon (NIMIC-NATO), *ICT Int. Jahrestg.* 1996, 18, 1 – 8, and references given in this paper.
- 96 B. M. Dobratz, *TATB, Development and Characterization 1888 to 1994, LA 13014 H, Aug. 1995, UC 741*, Los Alamos Nat. Lab. (NM 87545).
- 97 K. Y. Lee *et al.*, *J. Energ. Mat.* **5** (1987) no. 1, 27 – 33. A. Becuwe, A. Delclos, *ITC Int. Jahrestg.* 1987, 27, 1 – 14. M. Piteau, A. Becuwe, B. Finck, *ADPA, Compatibility of Plastics with Explosives, Proceedings*, San Diego 1991, 69 – 79.
- 98 A. Becuwe, A. Delclos, *Prof. Exp. Pyro.* **18**, 1993, 1–10.
- 99 A. Nielsen, *J. Org. Chem.* **55** (1990) 1459 – 1466.
- 100 V. A. Tartakowsky, O. A. Lukyanov, *ICT Int. Jahrestg.* 1994, 13, 1 – 9. A. Davenas, [18], 69 – 71. H. Hatano, *et al. Europyro (AFP), 6e Congres Int. Pyrotechnic Tours*, 1995, 23 – 26.
- 101 J. Boileau *et al.*, *Acta Cryst. Sect. C* **44** (1988) 696.
- 102 F. Bauer, H. Moulard, *4^e Symposium Hautes Pressions Dynamiques (AFP)*, 1995 333 – 340. R. A. Graham, L. M. Lee, F. Bauer, *Proceedings of Shock Waves in Condensed Matter*, Elsevier SC Publ. 1988, 619.
- 103 B. Blaive *et al.*, *Europyro (AFP), 6^e Congres Int. Pyrotechnic Tours*, 1995, 413 – 419.
- 104 H. Moulard, *9th Int. Symposium on Detonation (OCNR 113291–7)*, 1989, 18 – 24.
- 105 L. Borne, *10th Int. Symposium on Detonation (ONR 33395–12)*, 1993, 286 – 293.

Further Reading

- J. Akhavan: *Explosives and Propellants*, “Kirk Othmer Encyclopedia of Chemical Technology”, 5th edition, vol. 10, p. 719–744, John Wiley & Sons, Hoboken, 2005, online.
- J. Fraissard, O. Lapina: *Explosives Detection using Magnetic and Nuclear Resonance Techniques*, Springer, Dordrecht 2009.
- N. Kubota: *Propellants and Explosives*, 2nd ed., Wiley-VCH, Weinheim 2007.
- C. L. Mader: *Numerical Modeling of Explosives and Propellants*, 3rd ed., CRC Press, Boca Raton 2008.
- M. Marshall, J. C. Oxley: *Aspects of Explosives Detection*, Elsevier Science, Amsterdam, 2008.
- R. L. Woodfin: *Trace Chemical Sensing of Explosives*, Wiley, NJ 2007.
- J. Yinon: *Counterterrorist Detection Techniques of Explosives*, Elsevier Science, Amsterdam, 2007.